

E24RG12432LW2M300-C MCU 16BIT

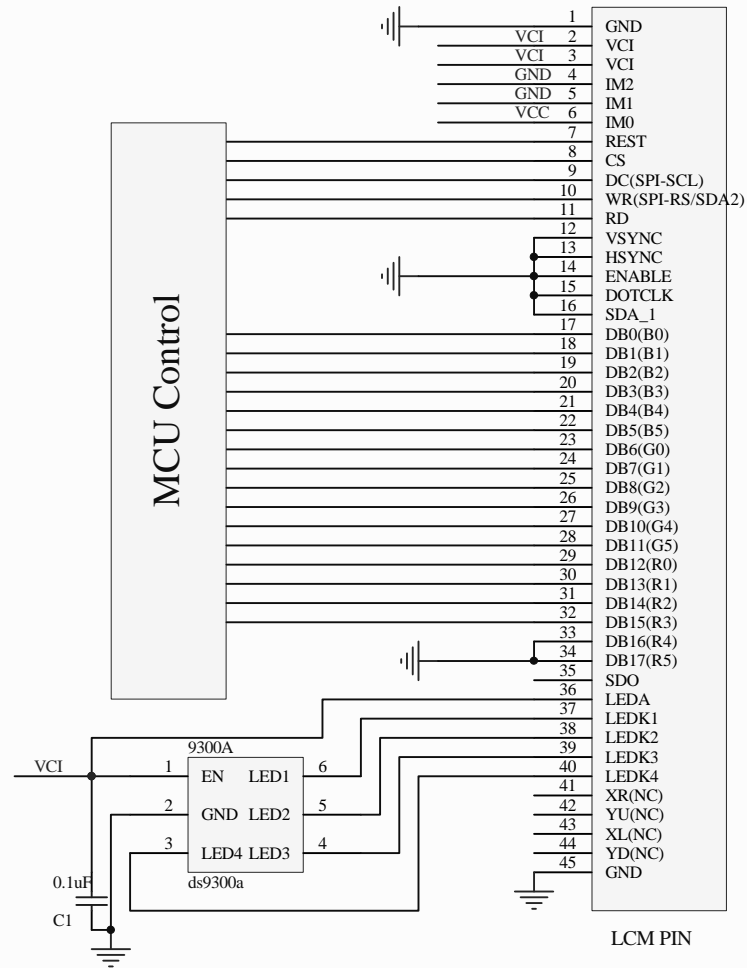

NOTE:
 1:Interface: MCU 16BIT
 2:SDO PIN if not used place OPEN
 3: VCC=3.3V