

# E35RG73248LW6M250-R MCU 8BIT

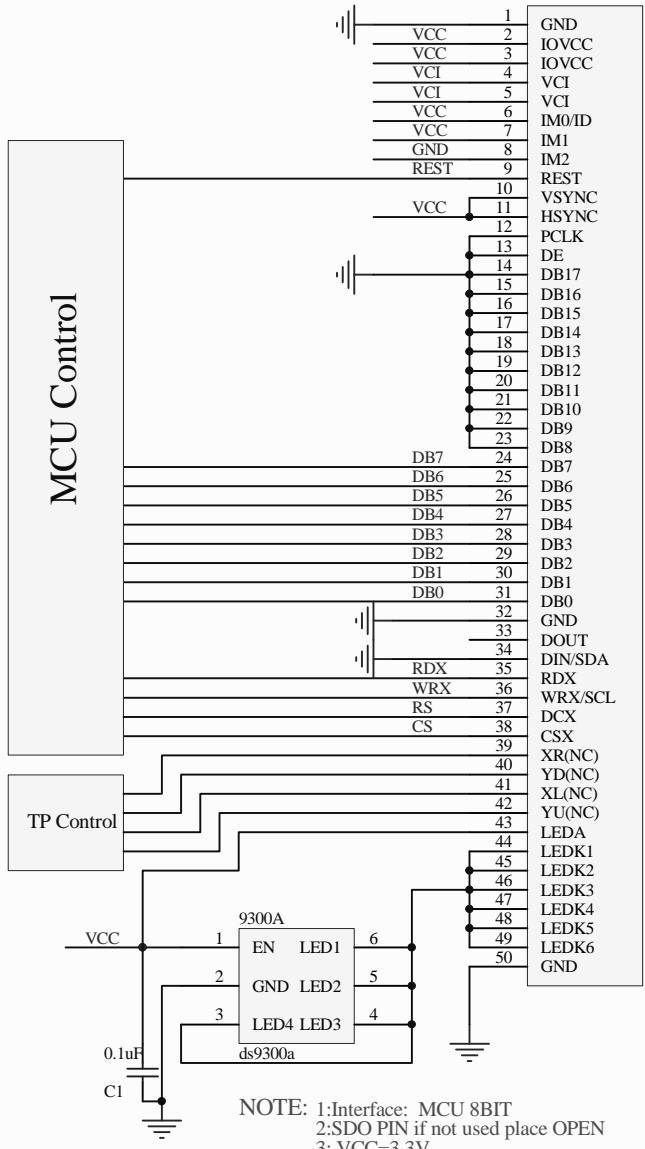

NOTE: 1:Interface: MCU 8BIT  
 2:SDO PIN if not used place OPEN  
 3: VCC=3.3V