

E35RG83224LW2M250-C 16BIT RGB

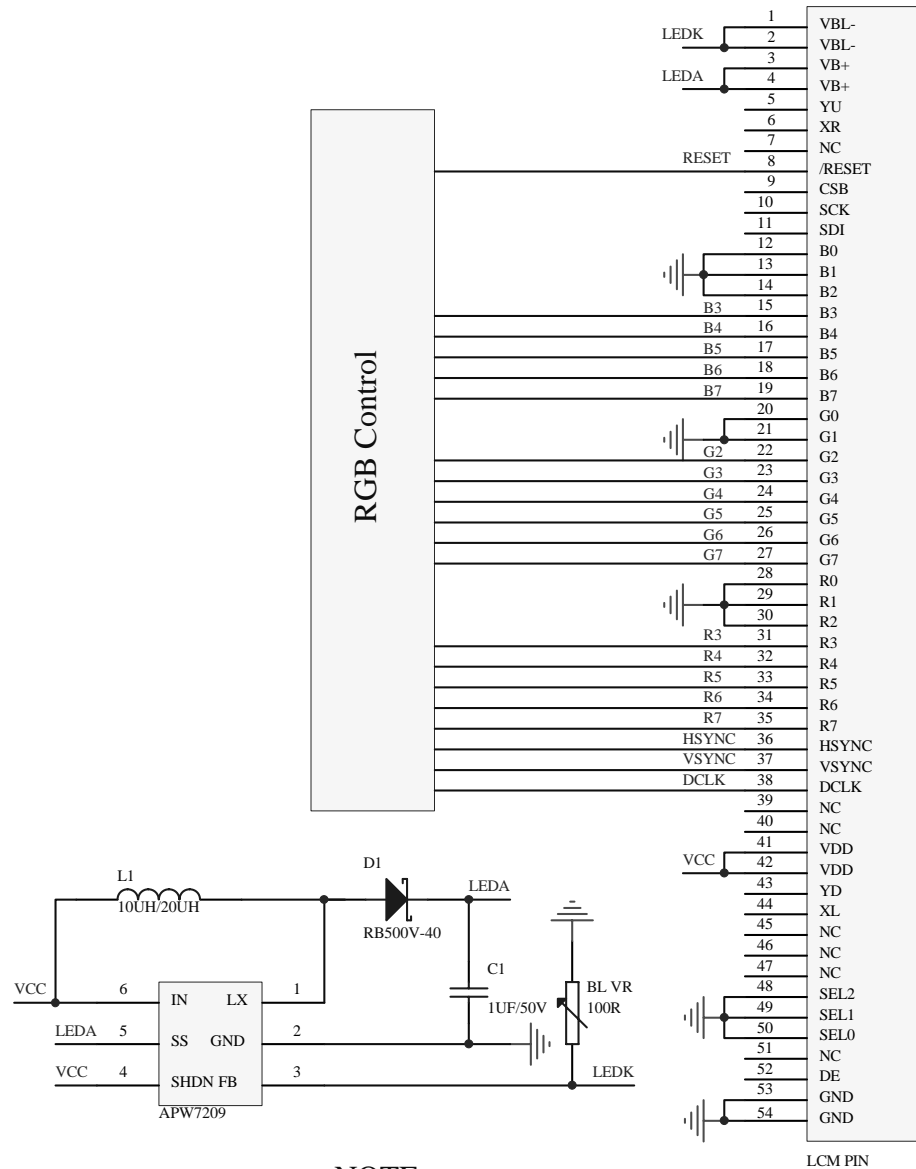

NOTE: 1.Interface: 16BIT RGB
2.VCC=3.3V