



# **EK73217A**

*Rev. 1.0*

DATA SHEET

**1200/1152/1080/960-Output**  
**TFT LCD Gate Driver**

*fitipower integrated technology Inc.*

**Table of Contents**

	Page
1. GENERAL DESCRIPTION .....	2
2. FEATURES .....	2
3. BLOCK DIAGRAM .....	3
4. PIN DESCRIPTION .....	4
5. FUNCTION DESCRIPTION .....	7
5.1. Device operation .....	7
5.2. Device power supply .....	7
5.3. Power ON/OFF sequence .....	8
5.4. Start Pulse LIMITATION .....	9
5.5. Output Sequence and Frame Control .....	10
6. ELECTRICAL SPECIFICATION .....	12
6.1. Absolute Maximum Ratings .....	12
6.2. Recommended Operating Range .....	12
6.3. DC Characteristics .....	13
6.4. AC Characteristics .....	14
6.5. Timing Waveform .....	14
6.6. Operation Timing .....	16
7. CHIP OUTLINE DIMENSIONS AND ALIGNMENT MARK .....	17
8. BUMP CENTER COORDINATE .....	18
9. DEFINITIONS .....	25
9.1 Data Sheet Status .....	25
9.2 Life Support Application .....	25
10 REVISION HISTORY .....	25

**1200/1152/1080/960-Output TFT LCD Gate Driver****1. GENERAL DESCRIPTION**

The EK73217A is a 1200/1152/1080/960-Output gate driver used for driving the gate electrode of TFT LCD panel. It is designed for 2-level output with maximum +40V output driving voltage.

**2. FEATURES**

- 2-level output gate driver for TFT LCD panel
- 1200/1152/1080/960-Output gate driver with 2 dummy outputs which are fixed to VGL
- Maximum +40V output driving voltage
- Logic operating voltage (VCC): 2.3 – 3.6V
- Bi-directional data shift capability
- 200 KHz maximum operation frequency
- High voltage CMOS process technology
- COG package
- Chip size=23650\*670 $\mu$ m
- Output bump pitch=18 $\mu$ m

3. BLOCK DIAGRAM

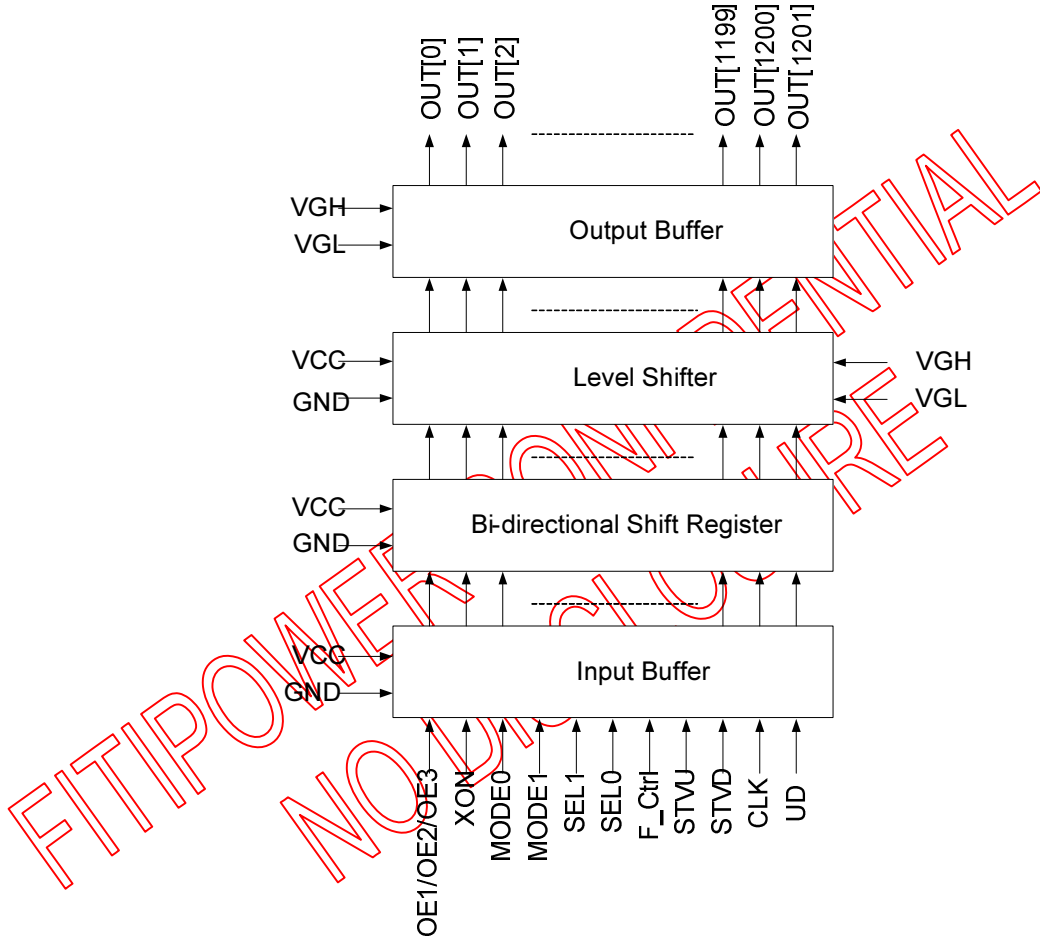

Figure 1. Block Diagram

## 4. PIN DESCRIPTION

Pin Name	Pin Type	Description									
CLKR/CLKL	I	This is the clock input for chip internal shift register. Data is shifted at each rising edge of this clock.									
UDR/UDL	I	This pin controls the output shifting direction as listed below. UD = H: STVD(input)→OUT[1]→OUT[2]→...→OUT[1200]→STVU UD = L: STVU(input)→OUT[1200]→...→OUT[2]→OUT[1]→STVD									
STVD STVU	I/O	These two pins are the device start pulse input or output pin. The function of these two pins depends on the status of UD pin. <table border="1" style="margin-left: auto; margin-right: auto;"> <thead> <tr> <th></th> <th>STVD</th> <th>STVU</th> </tr> </thead> <tbody> <tr> <td>UD = H</td> <td>input</td> <td>output</td> </tr> <tr> <td>UD = L</td> <td>output</td> <td>input</td> </tr> </tbody> </table>		STVD	STVU	UD = H	input	output	UD = L	output	input
	STVD	STVU									
UD = H	input	output									
UD = L	output	input									
OE1R/OE1L	I	The OE1 signal controls the OUT1, OUT4, OUT7...OUT1195, OUT1198 output enable. OE1,2,3="H": outputs are fixed to VGL regardless of CLK, However, the content of shift register is not cleared. OE1,2,3="L": Normal operation.									
OE2R/OE2L	I	The OE1 signal controls the OUT2, OUT5, OUT8...OUT1196, OUT1199 output enable. OE1,2,3="H": outputs are fixed to VGL regardless of CLK, However, the content of shift register is not cleared. OE1,2,3="L": Normal operation.									
OE3R/OE3L	I	The OE1 signal controls the OUT3, OUT6, OUT9...OUT1197, OUT1200 output enable. OE1,2,3="H": outputs are fixed to VGL regardless of CLK, However, the content of shift register is not cleared. OE1,2,3="L": Normal operation.									
XONR/XONL	IPH	When XON input pin is L, all the output pins are forced to VGH level. Note that this pin has higher priority than OE1/OE2/OE3. Also it has an internal pull high resistor, keep it to VCC is preferred when unused. The chip internal shift register is not cleared when XON input is active.									

MODE0R MODE0L MODE1R MODE1L	IPH	<p>Output channels select input. <b>MODE0/MODE1 are internally pulled high.</b></p> <p>Note: This pin should be connected to either “VCC” or “GND”.</p> <table border="1"> <thead> <tr> <th>MODE1</th> <th>MODE0</th> <th>Output Channels</th> <th>Disable channel</th> </tr> </thead> <tbody> <tr> <td>1</td> <td>1</td> <td>1200</td> <td>-</td> </tr> <tr> <td>1</td> <td>0</td> <td>1152</td> <td>OUT[577] ~ OUT[624]</td> </tr> <tr> <td>0</td> <td>1</td> <td>1080</td> <td>OUT[541] ~ OUT[660]</td> </tr> <tr> <td>0</td> <td>0</td> <td>960</td> <td>OUT[481] ~ OUT[720]</td> </tr> </tbody> </table>	MODE1	MODE0	Output Channels	Disable channel	1	1	1200	-	1	0	1152	OUT[577] ~ OUT[624]	0	1	1080	OUT[541] ~ OUT[660]	0	0	960	OUT[481] ~ OUT[720]
MODE1	MODE0	Output Channels	Disable channel																			
1	1	1200	-																			
1	0	1152	OUT[577] ~ OUT[624]																			
0	1	1080	OUT[541] ~ OUT[660]																			
0	0	960	OUT[481] ~ OUT[720]																			
SEL0R SEL0L SEL1R SEL1L	IPL	<p>Output sequence control inputs. These two pins control the driver output sequence. Internally pulled low.</p> <table border="1"> <thead> <tr> <th>SEL1</th> <th>SEL0</th> <th>Scan Type</th> </tr> </thead> <tbody> <tr> <td>1</td> <td>1</td> <td>Z+ Bow</td> </tr> <tr> <td>0</td> <td>1</td> <td>Bow</td> </tr> <tr> <td>X</td> <td>0</td> <td>Z</td> </tr> </tbody> </table>	SEL1	SEL0	Scan Type	1	1	Z+ Bow	0	1	Bow	X	0	Z								
SEL1	SEL0	Scan Type																				
1	1	Z+ Bow																				
0	1	Bow																				
X	0	Z																				
F_CtrlL F_CtrlR	IPL	<p>Frame control input. This pin decides to inverse the output sequence or not in odd or even frame. <b>Internally pulled low.</b></p>																				
OUT[1] ~ OUT[1200]	O	<p>The output voltage is either VGH or VGL for driving the gate electrode of TFT LCD panel depending on the data stored in shift register and the state of OE.</p>																				
OUT[0] OUT[1201]	O	<p>LCD panel auxiliary pins, these pins always output VGL level.</p>																				

Pin Name	Pin Type	Description
VCC	P	Digital power
GND	P	Digital ground
VGH	P	Power supply for OUT[1] ~ OUT[1200] drive output High
VGL	P	Power supply for OUT[1] ~ OUT[1200] drive output Low.
PATH1R,PATH1L PATH2R,PATH2L PATH3R,PATH3L	-	Linked together internal.
DUM2~DUM220	-	This pin is connected to GND internally. Not connected.

**Note:**

I: Input, IPH: Input with internal pull high, IPL: Input with internal low, O: Output, P: Power.

Pass line name

Pass line No.	Pad name	
1	OE1R	OE1L
2	OE2R	OE2L
3	OE3R	OE3L
4	UDR	UDL
5	CLKR	CLKL
6	PATH1R	PATH1L
7	PATH2R	PATH2L
8	PATH3R	PATH3L
9	VGH	VGH
10	VGL	VGL
11	VCC	VCC
12	GND	GND
13	MODE0R	MODE0L
14	MODE1R	MODE0L
15	SEL0R	SEL0L
16	SEL1R	SEL1L
17	F_CtrlR	F_CtrlL
18	XONR	XONL

FITIPOWER CONFIDENTIAL  
NO DISCLOSURE

**5. FUNCTION DESCRIPTION**

**5.1. Device operation**

In the condition of UD=H, the STVD start pulse input is sensed at the rising edge of CLK and stored in the first stage of shift register, which causes the first scan signal is output from the X1 output pin. While stored data is transferred to the next stage shift register at the rising edge of next CLK, new data of STVD is sensed and stored simultaneously.

The output pin (OUT[1] to OUT[1200]) supplies VGH voltage or VGL voltage to the LCD panel depending on the data stored in the shift register. For normal operation, a VGH voltage is output one by one from OUT[1] to OUT[1200] in sync with CLK pulse.

After 1200 CLK rising edge are past, the STVU goes up to high level at the 1200<sup>th</sup> falling edge of CLK and goes down to low level at the 1201<sup>th</sup> falling edge of CLK. This STVU output signal becomes the STVD start pulse input of next cascaded gate driver device.

During any "H" state of OE, the corresponding output channels are forced to VGL level regardless of CLK. The channel output returns to normal status as soon as OE go back to "L".

**5.2. Device power supply**

The EK73217A must be used by the following conditions.

\* VGH - VGL = 40V (max.)

\* VGH - GND = 7 ~ 35V

Example:

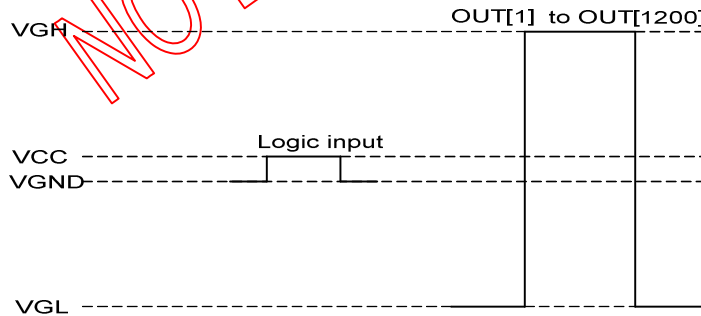

**Figure 2.** Device power supply



The input signal level of CLK, UD, OE, STVD, STVU, MODE0, MODE1, SEL1, SEL0, and F\_ctrl have to swing between VCC and GND. The signal output level of start pulse (STVU or STVD) to the next stage cascaded device is VCC for "H" and GND for "L".

### 5.3. Power ON/OFF sequence

To prevent the device from damage due to latch up, the power ON/OFF sequence shown below must be followed.

When power on: VCC→VGL→VGH

When power off: VGH→VGL→VCC

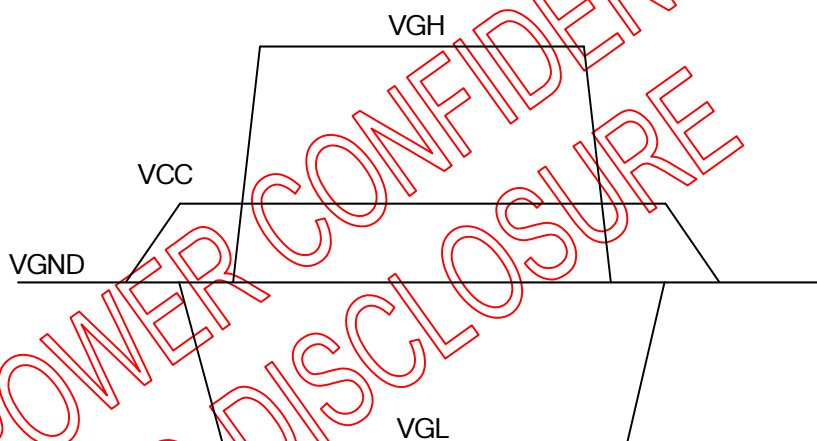
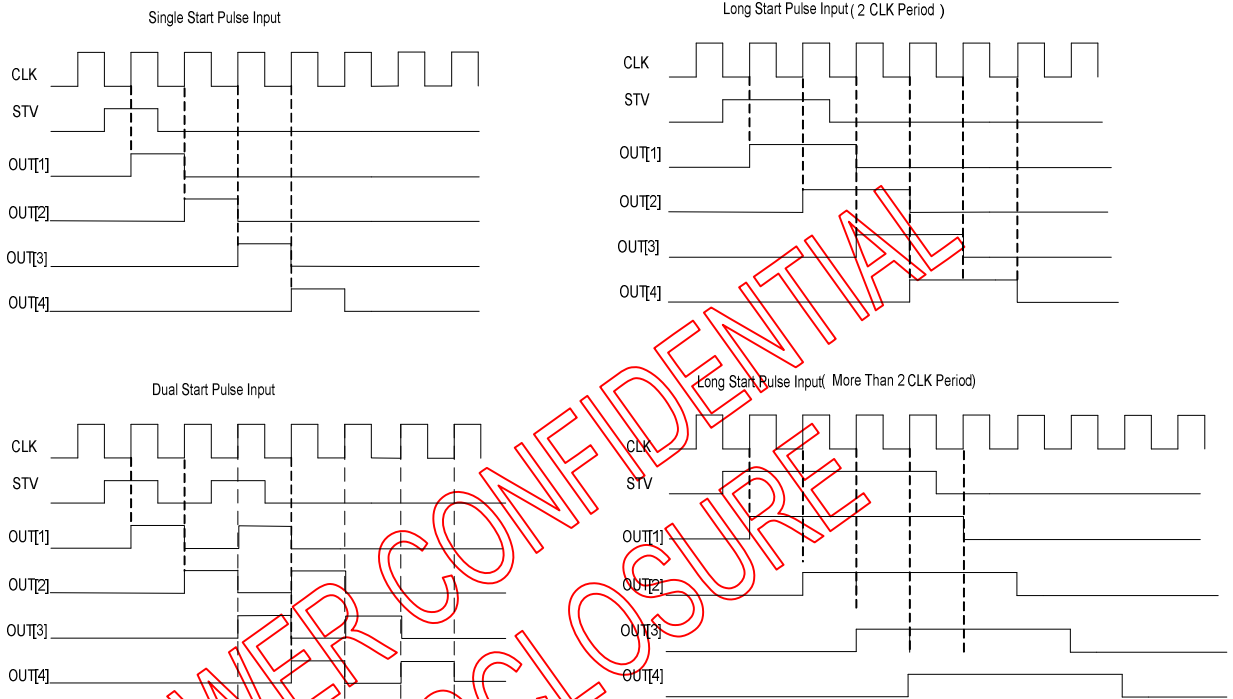

Figure 3. Power ON/OFF sequence

**5.4. Start Pulse LIMITATION**

The available start pulse is in the following diagram.

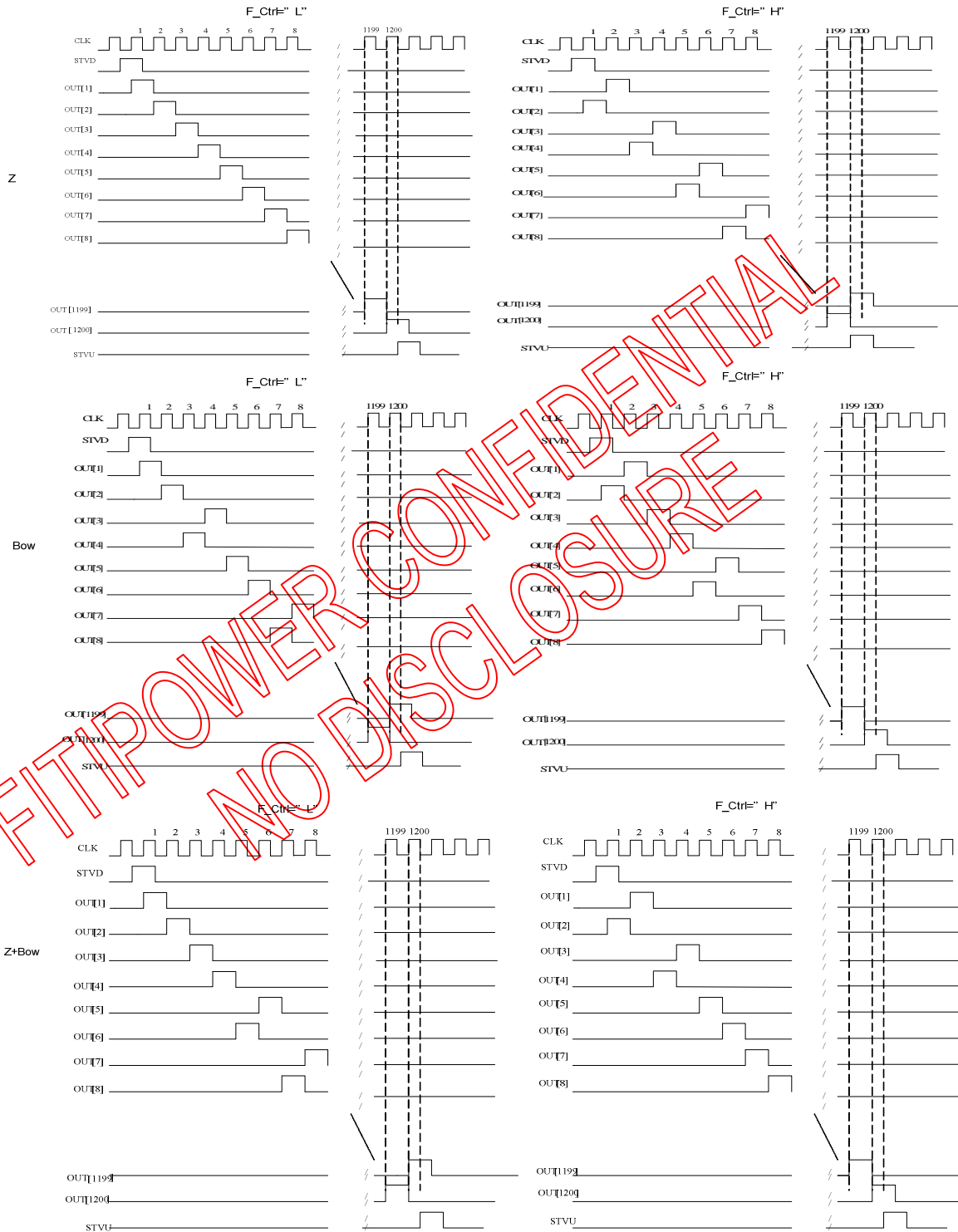

**Figure 4.** Start pulse Input limitation

Note: However the start pulse form changes, gate output keeps output sequentially.

**5.5. Output Sequence and Frame Control**

UD = H				
SEL0	SEL1	F_Ctrl	Scan Type	Output Sequence
1	1	0	Z + BOW	1→2→3→4→6→5→8→7→... (Note1)
		1	Inverse (Z+BOW)	2→1→4→3→5→6→7→8→...
1	0	0	BOW	1→2→4→3→5→6→8→7→... (Note2)
		1	Inverse BOW	2→1→3→4→6→5→7→8→...
0	X	0	Z	1→2→3→4→5→6→7→8→... (Note 3)
		1	Inverse Z	2→1→4→3→6→5→8→7→... (Note 4)
UD = L				
SEL0	SEL1	F_Ctrl	Scan Type	Output Sequence
1	1	0	Z + BOW	...8→7→6→5→3→4→1→2
		1	Inverse (Z+BOW)	...7→8→5→6→4→3→2→1
1	0	0	BOW	...8→7→5→6→4→3→1→2
		1	Inverse BOW	...7→8→6→5→3→4→2→1
0	X	0	Z	...8→7→6→5→4→3→2→1
		1	Inverse Z	...7→8→5→6→3→4→1→2



FTIPOWER CONFIDENTIAL  
NO DISCLOSURE

**6. ELECTRICAL SPECIFICATION**

**6.1. Absolute Maximum Ratings**

Absolute Maximum Ratings (GND = 0 V)

Parameter	Symbol	Rating	Unit
Power supply voltage (1)	VGH	-0.3 to +42.0	V
Power supply voltage (2)	VCC	-0.3 to +7.0	V
Power supply voltage (3)	VGL	-20 to +0.3	V
Power supply voltage (4)	VGH - VGL	-0.3 ~ +40	V
Input voltage	V <sub>IN</sub>	-0.3 to VCC+0.3	V
Storage temperature	T <sub>STG</sub>	-55 to +125	°C

Note 1: All of the voltages listed above are with respect to GND = 0V.

Note 2: Device is subject to be damaged permanently if stresses beyond those absolute maximum ratings listed above.

**6.2. Recommended Operating Range**

Recommended Operating Range (VGND = 0V)

Parameter	Symbol	Rating			Unit
		Min.	Typ.	Max.	
Power supply voltage (1)	VGH	7	-	35	V
Power supply voltage (2)	VCC	2.3	3.3	3.6	V
Power supply voltage (3)	VGL	-10	-	-3	V
Power supply voltage (4)	VGH -VGL	15	-	40	V
Operation frequency	FCLK	-	-	200	KHz
Operation temperature	T <sub>a</sub>	-20	-	+85	°C

### 6.3. DC Characteristics

DC Characteristic (VGH = 25V, VGL = -15V, VCC = 3.3V, GND = 0V, Ta = 25°C)

Parameter	Symbol	Condition	Rating			Unit	Application pin
			Min.	Typ.	Max.		
Input H voltage	V <sub>IH</sub>	-	0.7VCC	-	VCC	V	All input
Input L voltage	V <sub>IL</sub>	-	0	-	0.3VCC	V	All input
Output H voltage	V <sub>OH</sub>	I <sub>OH</sub> =40μA	VCC-0.4	-	VCC	V	STVU,D
Output L voltage	V <sub>OL</sub>	I <sub>OL</sub> =40μA	0	-	0.4	V	STVU,D
Output H resistance	R <sub>OH</sub>	V <sub>X</sub> = VGH -0.5V	-	-	1000	Ω	OUT[1] ~ OUT[1200]
Output L resistance	R <sub>OL</sub>	V <sub>X</sub> = VGL+0.5V	-	-	1000	Ω	OUT[1] ~ OUT[1200]
Input leakage current	I <sub>IN</sub>	-	-1.0	-	+1.0	μA	Note <sup>(2)</sup>
Pull high / low resistance	R <sub>PHI</sub>	V <sub>IN</sub> =VGND V <sub>IN</sub> =VCC	50	-	330	kΩ	XON, SEL1, SEL0, F_CTRL
VGH Power consumption	I <sub>VGH</sub>	Note <sup>(1)</sup>	-	50	250	μA	-
VGL Power consumption	I <sub>VGH</sub>	Note <sup>(1)</sup>	-	-50	-250	μA	-
VCC Power consumption	I <sub>VCC</sub>	Note <sup>(1)</sup>	-	15	100	μA	-

Note 1: Power consumption with the following condition: Output no load, VGH=25V, VGL=-15V, VCC=3.3V, V<sub>IH</sub> =VCC, V<sub>IL</sub>=GND, F<sub>Clk</sub> = 50 KHz, OE = V<sub>IL</sub>, XON= V<sub>IH</sub>.

Note 2: All input except XON, SEL1, SEL0, FCTRL

6.4. AC Characteristics

AC Characteristics (VGH = 25V, VGL = -15V, VCC = 3.3V, VGND = 0V, Ta = 25°C)

Parameter	Symbol	Condition	Rating			Unit
			Min.	Typ.	Max.	
CLK period	$t_{CLK}$	-	5	-	-	$\mu s$
CLK pulse width	$t_{CLKH}, t_{CLKL}$	50% duty cycle	2.5	-	-	$\mu s$
OE pulse width	$t_{WOE}$	-	1	-	-	$\mu s$
XON pulse width	$t_{WXAO}$	-	100	-	-	$\mu s$
Data setup time	$t_{SU}$	-	0.7	-	-	$\mu s$
Data hold time	$t_{HD}$	-	0.7	-	-	$\mu s$
CLK to output delay time	$t_{PD1}$	CL=300pF	-	-	1.2	$\mu s$
Start pulse output delay time	$t_{PD2}$	CL=30pF	-	-	1	$\mu s$
OE to output delay time	$t_{PD3}$	CL=300pF	-	-	1	$\mu s$
XON to output delay time	$t_{PD4}$	CL=300pF	-	-	100	$\mu s$
F_Ctrl setup time	$t_{MSU}$		1.0			$\mu s$
F_Ctrl hold time	$t_{MHD}$		1.0			$\mu s$

Note 1: The measurement point for all of above signals is at 50% of input/output amplitude.

6.5. Timing Waveform

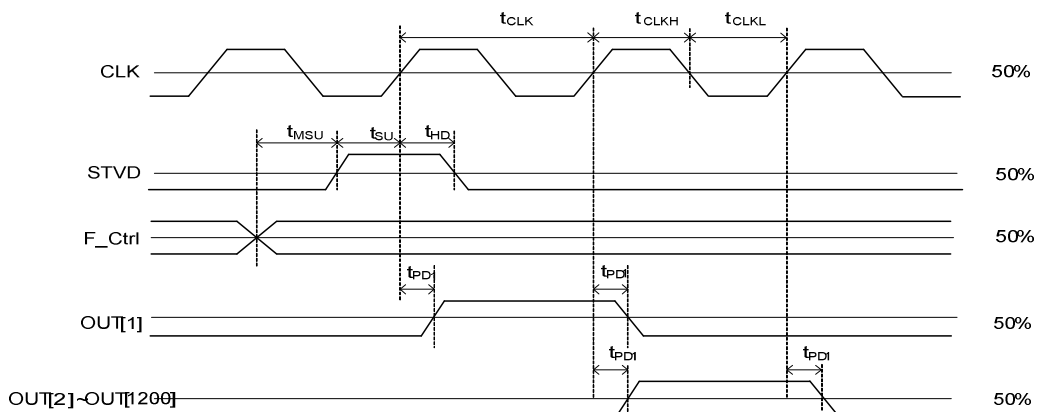

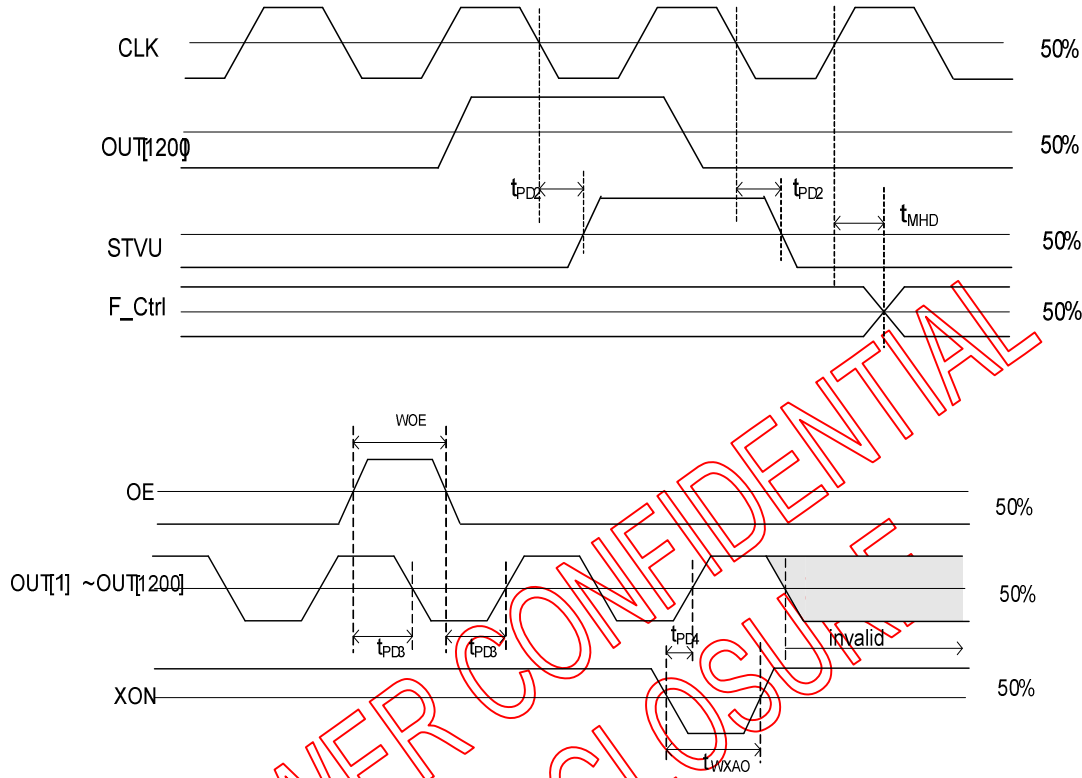

Figure 5. timing waveform



6.6. Operation Timing

UD="H"



Figure 6. Example of input/output timing (UD = H with OE and XON)

UD="L"

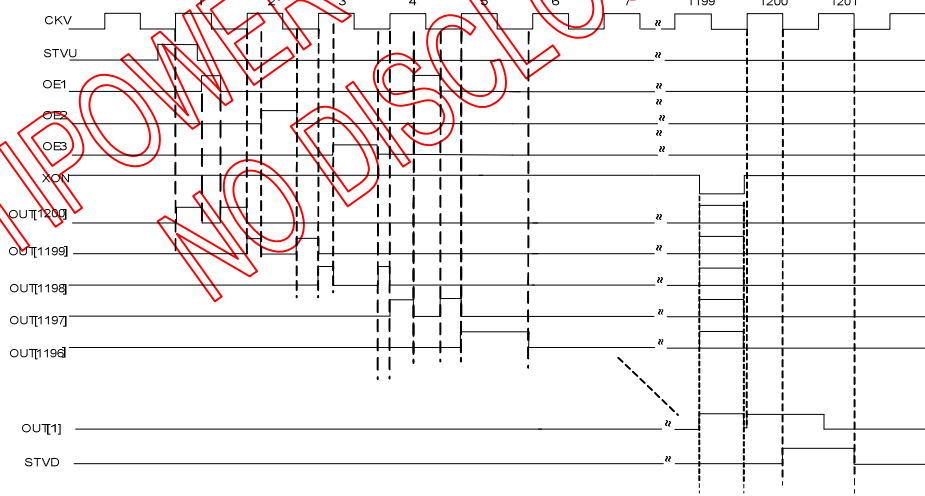
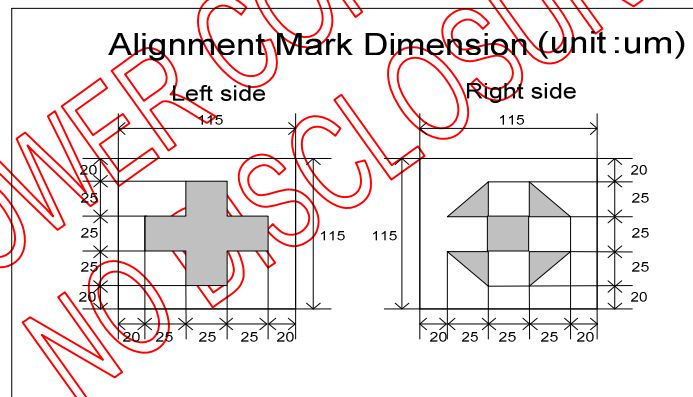
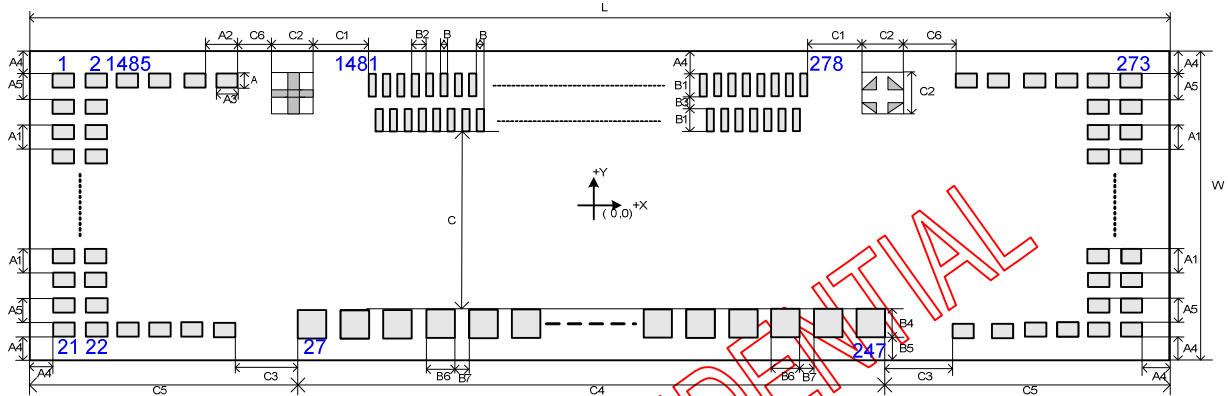

Figure 7. Example of input/output timing (UD = L with OE and XON)

## 7. CHIP OUTLINE DIMENSIONS AND ALIGNMENT MARK



Symbol	Dimensions	Symbol	Dimensions	Symbol	Dimensions
A	32	B2	36	C2	115
A1	52	B3	25	C3	208
A2	90	B4	70	C4	22080
A3	70	B5	57	C5	785
A4	57	B6	80	C6	89
A5	54	B7	20	L	23650
B	18	C	291	W	670
B1	85	C1	199	Unit : um	

## 8. BUMP CENTER COORDINATE

Pad #	Pad Name	Pad Coordinate		Pad #	Pad Name	Pad Coordinate		Pad #	Pad Name	Pad Coordinate	
		X	Y			X	Y			X	Y
1	OE1L	-11733	262	81	DUM55	-5600	-243	161	DUM135	2400	-243
2	OE1L	-11643	262	82	DUM56	-5500	-243	162	DUM136	2500	-243
3	OE2L	-11733	208	83	DUM57	-5400	-243	163	DUM137	2600	-243
4	OE2L	-11643	208	84	DUM58	-5300	-243	164	DUM138	2700	-243
5	OE3L	-11733	156	85	DUM59	-5200	-243	165	DUM139	2800	-243
6	OE3L	-11643	156	86	DUM60	-5100	-243	166	DUM140	2900	-243
7	UDL	-11733	104	87	DUM61	-5000	-243	167	DUM141	3000	-243
8	UDL	-11643	104	88	DUM62	-4900	-243	168	DUM142	3100	-243
9	CLKL	-11733	52	89	DUM63	-4800	-243	169	DUM143	3200	-243
10	CLKL	-11643	52	90	DUM64	-4700	-243	170	DUM144	3300	-243
11	PATH1L	-11733	0	91	DUM65	-4600	-243	171	DUM145	3400	-243
12	PATH1L	-11643	0	92	DUM66	-4500	-243	172	DUM146	3500	-243
13	STVUL	-11733	-52	93	DUM67	-4400	-243	173	DUM147	3600	-243
14	STVUL	-11643	-52	94	DUM68	-4300	-243	174	DUM148	3700	-243
15	VGH	-11733	-104	95	DUM69	-4200	-243	175	DUM149	3800	-243
16	VGH	-11643	-104	96	DUM70	-4100	-243	176	DUM150	3900	-243
17	VGL	-11733	-156	97	DUM71	-4000	-243	177	DUM151	4000	-243
18	VGL	-11643	-156	98	DUM72	-3900	-243	178	DUM152	4100	-243
19	VCC	-11733	-208	99	DUM73	-3800	-243	179	DUM153	4200	-243
20	VCC	-11643	-208	100	DUM74	-3700	-243	180	DUM154	4300	-243
21	GND	-11733	-262	101	DUM75	-3600	-243	181	DUM155	4400	-243
22	GND	-11643	-262	102	DUM76	-3500	-243	182	DUM156	4500	-243
23	MODE1L	-11553	-262	103	DUM77	-3400	-243	183	DUM157	4600	-243
24	MODE0L	-11463	-262	104	DUM78	-3300	-243	184	DUM158	4700	-243
25	SEL0L	-11373	-262	105	DUM79	-3200	-243	185	DUM159	4800	-243
26	SEL1L	-11283	-262	106	DUM80	-3100	-243	186	DUM160	4900	-243
27	PATH2L	-11000	-243	107	DUM81	-3000	-243	187	DUM161	5000	-243
28	DUM2	-10900	-243	108	DUM82	-2900	-243	188	DUM162	5100	-243
29	DUM3	-10800	-243	109	DUM83	-2800	-243	189	DUM163	5200	-243
30	DUM4	-10700	-243	110	DUM84	-2700	-243	190	DUM164	5300	-243
31	DUM5	-10600	-243	111	DUM85	-2600	-243	191	DUM165	5400	-243
32	DUM6	-10500	-243	112	DUM86	-2500	-243	192	DUM166	5500	-243
33	DUM7	-10400	-243	113	DUM87	-2400	-243	193	DUM167	5600	-243
34	DUM8	-10300	-243	114	DUM88	-2300	-243	194	DUM168	5700	-243
35	DUM9	-10200	-243	115	DUM89	-2200	-243	195	DUM169	5800	-243
36	DUM10	-10100	-243	116	DUM90	-2100	-243	196	DUM170	5900	-243
37	DUM11	-10000	-243	117	DUM91	-2000	-243	197	DUM171	6000	-243
38	DUM12	-9900	-243	118	DUM92	-1900	-243	198	DUM172	6100	-243
39	DUM13	-9800	-243	119	DUM93	-1800	-243	199	DUM173	6200	-243
40	DUM14	-9700	-243	120	DUM94	-1700	-243	200	DUM174	6300	-243
41	DUM15	-9600	-243	121	DUM95	-1600	-243	201	DUM175	6400	-243
42	DUM16	-9500	-243	122	DUM96	-1500	-243	202	DUM176	6500	-243
43	DUM17	-9400	-243	123	DUM97	-1400	-243	203	DUM177	6600	-243
44	DUM18	-9300	-243	124	DUM98	-1300	-243	204	DUM178	6700	-243
45	DUM19	-9200	-243	125	DUM99	-1200	-243	205	DUM179	6800	-243
46	DUM20	-9100	-243	126	DUM100	-1100	-243	206	DUM180	6900	-243
47	DUM21	-9000	-243	127	DUM101	-1000	-243	207	DUM181	7000	-243
48	DUM22	-8900	-243	128	DUM102	-900	-243	208	DUM182	7100	-243
49	DUM23	-8800	-243	129	DUM103	-800	-243	209	DUM183	7200	-243
50	DUM24	-8700	-243	130	DUM104	-700	-243	210	DUM184	7300	-243
51	DUM25	-8600	-243	131	DUM105	-600	-243	211	DUM185	7400	-243
52	DUM26	-8500	-243	132	DUM106	-500	-243	212	DUM186	7500	-243
53	DUM27	-8400	-243	133	DUM107	-400	-243	213	DUM187	7600	-243
54	DUM28	-8300	-243	134	DUM108	-300	-243	214	DUM188	7700	-243
55	DUM29	-8200	-243	135	DUM109	-200	-243	215	DUM189	7800	-243
56	DUM30	-8100	-243	136	DUM110	-100	-243	216	DUM190	7900	-243
57	DUM31	-8000	-243	137	DUM111	0	-243	217	DUM191	8000	-243
58	DUM32	-7900	-243	138	DUM112	100	-243	218	DUM192	8100	-243
59	DUM33	-7800	-243	139	DUM113	200	-243	219	DUM193	8200	-243
60	DUM34	-7700	-243	140	DUM114	300	-243	220	DUM194	8300	-243
61	DUM35	-7600	-243	141	DUM115	400	-243	221	DUM195	8400	-243
62	DUM36	-7500	-243	142	DUM116	500	-243	222	DUM196	8500	-243
63	DUM37	-7400	-243	143	DUM117	600	-243	223	DUM197	8600	-243
64	DUM38	-7300	-243	144	DUM118	700	-243	224	DUM198	8700	-243
65	DUM39	-7200	-243	145	DUM119	800	-243	225	DUM199	8800	-243
66	DUM40	-7100	-243	146	DUM120	900	-243	226	DUM200	8900	-243
67	DUM41	-7000	-243	147	DUM121	1000	-243	227	DUM201	9000	-243
68	DUM42	-6900	-243	148	DUM122	1100	-243	228	DUM202	9100	-243
69	DUM43	-6800	-243	149	DUM123	1200	-243	229	DUM203	9200	-243
70	DUM44	-6700	-243	150	DUM124	1300	-243	230	DUM204	9300	-243
71	DUM45	-6600	-243	151	DUM125	1400	-243	231	DUM205	9400	-243
72	DUM46	-6500	-243	152	DUM126	1500	-243	232	DUM206	9500	-243
73	DUM47	-6400	-243	153	DUM127	1600	-243	233	DUM207	9600	-243
74	DUM48	-6300	-243	154	DUM128	1700	-243	234	DUM208	9700	-243
75	DUM49	-6200	-243	155	DUM129	1800	-243	235	DUM209	9800	-243
76	DUM50	-6100	-243	156	DUM130	1900	-243	236	DUM210	9900	-243
77	DUM51	-6000	-243	157	DUM131	2000	-243	237	DUM211	10000	-243
78	DUM52	-5900	-243	158	DUM132	2100	-243	238	DUM212	10100	-243
79	DUM53	-5800	-243	159	DUM133	2200	-243	239	DUM213	10200	-243
80	DUM54	-5700	-243	160	DUM134	2300	-243	240	DUM214	10300	-243

Pad #	Pad Name	Pad Coordinate	
		X	Y
241	DUM215	10400	-243
242	DUM216	10500	-243
243	DUM217	10600	-243
244	DUM218	10700	-243
245	DUM219	10800	-243
246	DUM220	10900	-243
247	PATH2R	11000	-243
248	SEL1R	11283	-262
249	SEL0R	11373	-262
250	MODE0R	11463	-262
251	MODE1R	11553	-262
252	GND	11643	-262
253	GND	11733	-262
254	VCC	11643	-208
255	VCC	11733	-208
256	VGL	11643	-156
257	VGL	11733	-156
258	VGH	11643	-104
259	VGH	11733	-104
260	STVDR	11643	-52
261	STVDR	11733	-52
262	PATH1R	11643	0
263	PATH1R	11733	0
264	CLKR	11643	52
265	CLKR	11733	52
266	UDR	11643	104
267	UDR	11733	104
268	OE3R	11643	156
269	OE3R	11733	156
270	OE2R	11643	208
271	OE2R	11733	208
272	OE1R	11643	262
273	OE1R	11733	262
274	F_CTRLR	11553	262
275	F_CTRLR	11463	262
276	XONR	11373	262
277	XONR	11283	262
278	PATH3R	10836	235.5
279	OUT[0]	10800	235.5
280	OUT[1]	10782	235.5
281	OUT[2]	10764	235.5
282	OUT[3]	10746	235.5
283	OUT[4]	10728	235.5
284	OUT[5]	10710	235.5
285	OUT[6]	10692	235.5
286	OUT[7]	10674	235.5
287	OUT[8]	10656	235.5
288	OUT[9]	10638	235.5
289	OUT[10]	10620	235.5
290	OUT[11]	10602	235.5
291	OUT[12]	10584	235.5
292	OUT[13]	10566	235.5
293	OUT[14]	10548	235.5
294	OUT[15]	10530	235.5
295	OUT[16]	10512	235.5
296	OUT[17]	10494	235.5
297	OUT[18]	10476	235.5
298	OUT[19]	10458	235.5
299	OUT[20]	10440	235.5
300	OUT[21]	10422	235.5
301	OUT[22]	10404	235.5
302	OUT[23]	10386	235.5
303	OUT[24]	10368	235.5
304	OUT[25]	10350	235.5
305	OUT[26]	10332	235.5
306	OUT[27]	10314	235.5
307	OUT[28]	10296	235.5
308	OUT[29]	10278	235.5
309	OUT[30]	10260	235.5
310	OUT[31]	10242	235.5
311	OUT[32]	10224	235.5
312	OUT[33]	10206	235.5
313	OUT[34]	10188	235.5
314	OUT[35]	10170	235.5
315	OUT[36]	10152	235.5
316	OUT[37]	10134	235.5
317	OUT[38]	10116	235.5
318	OUT[39]	10098	235.5
319	OUT[40]	10080	235.5
320	OUT[41]	10062	235.5

Pad #	Pad Name	Pad Coordinate	
		X	Y
321	OUT[42]	10044	235.5
322	OUT[43]	10026	235.5
323	OUT[44]	10008	235.5
324	OUT[45]	9990	235.5
325	OUT[46]	9972	235.5
326	OUT[47]	9954	235.5
327	OUT[48]	9936	235.5
328	OUT[49]	9918	235.5
329	OUT[50]	9900	235.5
330	OUT[51]	9882	235.5
331	OUT[52]	9864	235.5
332	OUT[53]	9846	235.5
333	OUT[54]	9828	235.5
334	OUT[55]	9810	235.5
335	OUT[56]	9792	235.5
336	OUT[57]	9774	235.5
337	OUT[58]	9756	235.5
338	OUT[59]	9738	235.5
339	OUT[60]	9720	235.5
340	OUT[61]	9702	235.5
341	OUT[62]	9684	235.5
342	OUT[63]	9666	235.5
343	OUT[64]	9648	235.5
344	OUT[65]	9630	235.5
345	OUT[66]	9612	235.5
346	OUT[67]	9594	235.5
347	OUT[68]	9576	235.5
348	OUT[69]	9558	235.5
349	OUT[70]	9540	235.5
350	OUT[71]	9522	235.5
351	OUT[72]	9504	235.5
352	OUT[73]	9486	235.5
353	OUT[74]	9468	235.5
354	OUT[75]	9450	235.5
355	OUT[76]	9432	235.5
356	OUT[77]	9414	235.5
357	OUT[78]	9396	235.5
358	OUT[79]	9378	235.5
359	OUT[80]	9360	235.5
360	OUT[81]	9342	235.5
361	OUT[82]	9324	235.5
362	OUT[83]	9306	235.5
363	OUT[84]	9288	235.5
364	OUT[85]	9270	235.5
365	OUT[86]	9252	235.5
366	OUT[87]	9234	235.5
367	OUT[88]	9216	235.5
368	OUT[89]	9198	235.5
369	OUT[90]	9180	235.5
370	OUT[91]	9162	235.5
371	OUT[92]	9144	235.5
372	OUT[93]	9126	235.5
373	OUT[94]	9108	235.5
374	OUT[95]	9090	235.5
375	OUT[96]	9072	235.5
376	OUT[97]	9054	235.5
377	OUT[98]	9036	235.5
378	OUT[99]	9018	235.5
379	OUT[100]	9000	235.5
380	OUT[101]	8982	235.5
381	OUT[102]	8964	235.5
382	OUT[103]	8946	235.5
383	OUT[104]	8928	235.5
384	OUT[105]	8910	235.5
385	OUT[106]	8892	235.5
386	OUT[107]	8874	235.5
387	OUT[108]	8856	235.5
388	OUT[109]	8838	235.5
389	OUT[110]	8820	235.5
390	OUT[111]	8802	235.5
391	OUT[112]	8784	235.5
392	OUT[113]	8766	235.5
393	OUT[114]	8748	235.5
394	OUT[115]	8730	235.5
395	OUT[116]	8712	235.5
396	OUT[117]	8694	235.5
397	OUT[118]	8676	235.5
398	OUT[119]	8658	235.5
399	OUT[120]	8640	235.5
400	OUT[121]	8622	235.5

Pad #	Pad Name	Pad Coordinate	
		X	Y
401	OUT[122]	8604	235.5
402	OUT[123]	8586	235.5
403	OUT[124]	8568	235.5
404	OUT[125]	8550	235.5
405	OUT[126]	8532	235.5
406	OUT[127]	8514	235.5
407	OUT[128]	8496	235.5
408	OUT[129]	8478	235.5
409	OUT[130]	8460	235.5
410	OUT[131]	8442	235.5
411	OUT[132]	8424	235.5
412	OUT[133]	8406	235.5
413	OUT[134]	8388	235.5
414	OUT[135]	8370	235.5
415	OUT[136]	8352	235.5
416	OUT[137]	8334	235.5
417	OUT[138]	8316	235.5
418	OUT[139]	8298	235.5
419	OUT[140]	8280	235.5
420	OUT[141]	8262	235.5
421	OUT[142]	8244	235.5
422	OUT[143]	8226	235.5
423	OUT[144]	8208	235.5
424	OUT[145]	8190	235.5
425	OUT[146]	8172	235.5
426	OUT[147]	8154	235.5
427	OUT[148]	8136	235.5
428	OUT[149]	8118	235.5
429	OUT[150]	8100	235.5
430	OUT[151]	8082	235.5
431	OUT[152]	8064	235.5
432	OUT[153]	8046	235.5
433	OUT[154]	8028	235.5
434	OUT[155]	8010	235.5
435	OUT[156]	7992	235.5
436	OUT[157]	7974	235.5
437	OUT[158]	7956	235.5
438	OUT[159]	7938	235.5
439	OUT[160]	7920	235.5
440	OUT[161]	7902	235.5
441	OUT[162]	7884	235.5
442	OUT[163]	7866	235.5
443	OUT[164]	7848	235.5
444	OUT[165]	7830	235.5
445	OUT[166]	7812	235.5
446	OUT[167]	7794	235.5
447	OUT[168]	7776	235.5
448	OUT[169]	7758	235.5
449	OUT[170]	7740	235.5
450	OUT[171]	7722	235.5
451	OUT[172]	7704	235.5
452	OUT[173]	7686	235.5
453	OUT[174]	7668	235.5
454	OUT[175]	7650	235.5
455	OUT[176]	7632	235.5
456	OUT[177]	7614	235.5
457	OUT[178]	7596	235.5
458	OUT[179]	7578	235.5
459	OUT[180]	7560	235.5
460	OUT[181]	7542	235.5
461	OUT[182]	7524	235.5
462	OUT[183]	7506	235.5
463	OUT[184]	7488	235.5
464	OUT[185]	7470	235.5
465	OUT[186]	7452	235.5
466	OUT[187]	7434	235.5
467	OUT[188]	7416	235.5
468	OUT[189]	7398	235.5
469	OUT[190]	7380	235.5
470	OUT[191]	7362	235.5
471	OUT[192]	7344	235.5
472	OUT[193]	7326	235.5
473	OUT[194]	7308	235.5
474	OUT[195]	7290	235.5
475	OUT[196]	7272	235.5
476	OUT[197]	7254	235.5
477	OUT[198]	7236	235.5
478	OUT[199]	7218	235.5
479	OUT[200]	7200	235.5
480	OUT[201]	7182	235.5

Pad #	Pad Name	Pad Coordinate	
		X	Y
481	OUT[202]	7164	235.5
482	OUT[203]	7146	125.5
483	OUT[204]	7128	235.5
484	OUT[205]	7110	125.5
485	OUT[206]	7092	235.5
486	OUT[207]	7074	125.5
487	OUT[208]	7056	235.5
488	OUT[209]	7038	125.5
489	OUT[210]	7020	235.5
490	OUT[211]	7002	125.5
491	OUT[212]	6984	235.5
492	OUT[213]	6966	125.5
493	OUT[214]	6948	235.5
494	OUT[215]	6930	125.5
495	OUT[216]	6912	235.5
496	OUT[217]	6894	125.5
497	OUT[218]	6876	235.5
498	OUT[219]	6858	125.5
499	OUT[220]	6840	235.5
500	OUT[221]	6822	125.5
501	OUT[222]	6804	235.5
502	OUT[223]	6786	125.5
503	OUT[224]	6768	235.5
504	OUT[225]	6750	125.5
505	OUT[226]	6732	235.5
506	OUT[227]	6714	125.5
507	OUT[228]	6696	235.5
508	OUT[229]	6678	125.5
509	OUT[230]	6660	235.5
510	OUT[231]	6642	125.5
511	OUT[232]	6624	235.5
512	OUT[233]	6606	125.5
513	OUT[234]	6588	235.5
514	OUT[235]	6570	125.5
515	OUT[236]	6552	235.5
516	OUT[237]	6534	125.5
517	OUT[238]	6516	235.5
518	OUT[239]	6498	125.5
519	OUT[240]	6480	235.5
520	OUT[241]	6462	125.5
521	OUT[242]	6444	235.5
522	OUT[243]	6426	125.5
523	OUT[244]	6408	235.5
524	OUT[245]	6390	125.5
525	OUT[246]	6372	235.5
526	OUT[247]	6354	125.5
527	OUT[248]	6336	235.5
528	OUT[249]	6318	125.5
529	OUT[250]	6300	235.5
530	OUT[251]	6282	125.5
531	OUT[252]	6264	235.5
532	OUT[253]	6246	125.5
533	OUT[254]	6228	235.5
534	OUT[255]	6210	125.5
535	OUT[256]	6192	235.5
536	OUT[257]	6174	125.5
537	OUT[258]	6156	235.5
538	OUT[259]	6138	125.5
539	OUT[260]	6120	235.5
540	OUT[261]	6102	125.5
541	OUT[262]	6084	235.5
542	OUT[263]	6066	125.5
543	OUT[264]	6048	235.5
544	OUT[265]	6030	125.5
545	OUT[266]	6012	235.5
546	OUT[267]	5994	125.5
547	OUT[268]	5976	235.5
548	OUT[269]	5958	125.5
549	OUT[270]	5940	235.5
550	OUT[271]	5922	125.5
551	OUT[272]	5904	235.5
552	OUT[273]	5886	125.5
553	OUT[274]	5868	235.5
554	OUT[275]	5850	125.5
555	OUT[276]	5832	235.5
556	OUT[277]	5814	125.5
557	OUT[278]	5796	235.5
558	OUT[279]	5778	125.5
559	OUT[280]	5760	235.5
560	OUT[281]	5742	125.5

Pad #	Pad Name	Pad Coordinate	
		X	Y
561	OUT[282]	5724	235.5
562	OUT[283]	5706	125.5
563	OUT[284]	5688	235.5
564	OUT[285]	5670	125.5
565	OUT[286]	5652	235.5
566	OUT[287]	5634	125.5
567	OUT[288]	5616	235.5
568	OUT[289]	5598	125.5
569	OUT[290]	5580	235.5
570	OUT[291]	5562	125.5
571	OUT[292]	5544	235.5
572	OUT[293]	5526	125.5
573	OUT[294]	5508	235.5
574	OUT[295]	5490	125.5
575	OUT[296]	5472	235.5
576	OUT[297]	5454	125.5
577	OUT[298]	5436	235.5
578	OUT[299]	5418	125.5
579	OUT[300]	5400	235.5
580	OUT[301]	5382	125.5
581	OUT[302]	5364	235.5
582	OUT[303]	5346	125.5
583	OUT[304]	5328	235.5
584	OUT[305]	5310	125.5
585	OUT[306]	5292	235.5
586	OUT[307]	5274	125.5
587	OUT[308]	5256	235.5
588	OUT[309]	5238	125.5
589	OUT[310]	5220	235.5
590	OUT[311]	5202	125.5
591	OUT[312]	5184	235.5
592	OUT[313]	5166	125.5
593	OUT[314]	5148	235.5
594	OUT[315]	5130	125.5
595	OUT[316]	5112	235.5
596	OUT[317]	5094	125.5
597	OUT[318]	5076	235.5
598	OUT[319]	5058	125.5
599	OUT[320]	5040	235.5
600	OUT[321]	5022	125.5
601	OUT[322]	5004	235.5
602	OUT[323]	4986	125.5
603	OUT[324]	4968	235.5
604	OUT[325]	4950	125.5
605	OUT[326]	4932	235.5
606	OUT[327]	4914	125.5
607	OUT[328]	4896	235.5
608	OUT[329]	4878	125.5
609	OUT[330]	4860	235.5
610	OUT[331]	4842	125.5
611	OUT[332]	4824	235.5
612	OUT[333]	4806	125.5
613	OUT[334]	4788	235.5
614	OUT[335]	4770	125.5
615	OUT[336]	4752	235.5
616	OUT[337]	4734	125.5
617	OUT[338]	4716	235.5
618	OUT[339]	4698	125.5
619	OUT[340]	4680	235.5
620	OUT[341]	4662	125.5
621	OUT[342]	4644	235.5
622	OUT[343]	4626	125.5
623	OUT[344]	4608	235.5
624	OUT[345]	4590	125.5
625	OUT[346]	4572	235.5
626	OUT[347]	4554	125.5
627	OUT[348]	4536	235.5
628	OUT[349]	4518	125.5
629	OUT[350]	4500	235.5
630	OUT[351]	4482	125.5
631	OUT[352]	4464	235.5
632	OUT[353]	4446	125.5
633	OUT[354]	4428	235.5
634	OUT[355]	4410	125.5
635	OUT[356]	4392	235.5
636	OUT[357]	4374	125.5
637	OUT[358]	4356	235.5
638	OUT[359]	4338	125.5
639	OUT[360]	4320	235.5
640	OUT[361]	4302	125.5

Pad #	Pad Name	Pad Coordinate	
		X	Y
641	OUT[362]	4284	235.5
642	OUT[363]	4266	125.5
643	OUT[364]	4248	235.5
644	OUT[365]	4230	125.5
645	OUT[366]	4212	235.5
646	OUT[367]	4194	125.5
647	OUT[368]	4176	235.5
648	OUT[369]	4158	125.5
649	OUT[370]	4140	235.5
650	OUT[371]	4122	125.5
651	OUT[372]	4104	235.5
652	OUT[373]	4086	125.5
653	OUT[374]	4068	235.5
654	OUT[375]	4050	125.5
655	OUT[376]	4032	235.5
656	OUT[377]	4014	125.5
657	OUT[378]	3996	235.5
658	OUT[379]	3978	125.5
659	OUT[380]	3960	235.5
660	OUT[381]	3942	125.5
661	OUT[382]	3924	235.5
662	OUT[383]	3906	125.5
663	OUT[384]	3888	235.5
664	OUT[385]	3870	125.5
665	OUT[386]	3852	235.5
666	OUT[387]	3834	125.5
667	OUT[388]	3816	235.5
668	OUT[389]	3798	125.5
669	OUT[390]	3780	235.5
670	OUT[391]	3762	125.5
671	OUT[392]	3744	235.5
672	OUT[393]	3726	125.5
673	OUT[394]	3708	235.5
674	OUT[395]	3690	125.5
675	OUT[396]	3672	235.5
676	OUT[397]	3654	125.5
677	OUT[398]	3636	235.5
678	OUT[399]	3618	125.5
679	OUT[400]	3600	235.5
680	OUT[401]	3582	125.5
681	OUT[402]	3564	235.5
682	OUT[403]	3546	125.5
683	OUT[404]	3528	235.5
684	OUT[405]	3510	125.5
685	OUT[406]	3492	235.5
686	OUT[407]	3474	125.5
687	OUT[408]	3456	235.5
688	OUT[409]	3438	125.5
689	OUT[410]	3420	235.5
690	OUT[411]	3402	125.5
691	OUT[412]	3384	235.5
692	OUT[413]	3366	125.5
693	OUT[414]	3348	235.5
694	OUT[415]	3330	125.5
695	OUT[416]	3312	235.5
696	OUT[417]	3294	125.5
697	OUT[418]	3276	235.5
698	OUT[419]	3258	125.5
699	OUT[420]	3240	235.5
700	OUT[421]	3222	125.5
701	OUT[422]	3204	235.5
702	OUT[423]	3186	125.5
703	OUT[424]	3168	235.5
704	OUT[425]	3150	125.5
705	OUT[426]	3132	235.5
706	OUT[427]	3114	125.5
707	OUT[428]	3096	235.5
708	OUT[429]	3078	125.5
709	OUT[430]	3060	235.5
710	OUT[431]	3042	125.5
711	OUT[432]	3024	235.5
712	OUT[433]	3006	125.5
713	OUT[434]	2988	235.5
714	OUT[435]	2970	125.5
715	OUT[436]	2952	235.5
716	OUT[437]	2934	125.5
717	OUT[438]	2916	235.5
718	OUT[439]	2898	125.5
719	OUT[440]	2880	235.5
720	OUT[441]	2862	125.5

Pad #	Pad Name	Pad Coordinate	
		X	Y
721	OUT[442]	2844	235.5
722	OUT[443]	2826	125.5
723	OUT[444]	2808	235.5
724	OUT[445]	2790	125.5
725	OUT[446]	2772	235.5
726	OUT[447]	2754	125.5
727	OUT[448]	2736	235.5
728	OUT[449]	2718	125.5
729	OUT[450]	2700	235.5
730	OUT[451]	2682	125.5
731	OUT[452]	2664	235.5
732	OUT[453]	2646	125.5
733	OUT[454]	2628	235.5
734	OUT[455]	2610	125.5
735	OUT[456]	2592	235.5
736	OUT[457]	2574	125.5
737	OUT[458]	2556	235.5
738	OUT[459]	2538	125.5
739	OUT[460]	2520	235.5
740	OUT[461]	2502	125.5
741	OUT[462]	2484	235.5
742	OUT[463]	2466	125.5
743	OUT[464]	2448	235.5
744	OUT[465]	2430	125.5
745	OUT[466]	2412	235.5
746	OUT[467]	2394	125.5
747	OUT[468]	2376	235.5
748	OUT[469]	2358	125.5
749	OUT[470]	2340	235.5
750	OUT[471]	2322	125.5
751	OUT[472]	2304	235.5
752	OUT[473]	2286	125.5
753	OUT[474]	2268	235.5
754	OUT[475]	2250	125.5
755	OUT[476]	2232	235.5
756	OUT[477]	2214	125.5
757	OUT[478]	2196	235.5
758	OUT[479]	2178	125.5
759	OUT[480]	2160	235.5
760	OUT[481]	2142	125.5
761	OUT[482]	2124	235.5
762	OUT[483]	2106	125.5
763	OUT[484]	2088	235.5
764	OUT[485]	2070	125.5
765	OUT[486]	2052	235.5
766	OUT[487]	2034	125.5
767	OUT[488]	2016	235.5
768	OUT[489]	1998	125.5
769	OUT[490]	1980	235.5
770	OUT[491]	1962	125.5
771	OUT[492]	1944	235.5
772	OUT[493]	1926	125.5
773	OUT[494]	1908	235.5
774	OUT[495]	1890	125.5
775	OUT[496]	1872	235.5
776	OUT[497]	1854	125.5
777	OUT[498]	1836	235.5
778	OUT[499]	1818	125.5
779	OUT[500]	1800	235.5
780	OUT[501]	1782	125.5
781	OUT[502]	1764	235.5
782	OUT[503]	1746	125.5
783	OUT[504]	1728	235.5
784	OUT[505]	1710	125.5
785	OUT[506]	1692	235.5
786	OUT[507]	1674	125.5
787	OUT[508]	1656	235.5
788	OUT[509]	1638	125.5
789	OUT[510]	1620	235.5
790	OUT[511]	1602	125.5
791	OUT[512]	1584	235.5
792	OUT[513]	1566	125.5
793	OUT[514]	1548	235.5
794	OUT[515]	1530	125.5
795	OUT[516]	1512	235.5
796	OUT[517]	1494	125.5
797	OUT[518]	1476	235.5
798	OUT[519]	1458	125.5
799	OUT[520]	1440	235.5
800	OUT[521]	1422	125.5

Pad #	Pad Name	Pad Coordinate	
		X	Y
801	OUT[522]	1404	235.5
802	OUT[523]	1386	125.5
803	OUT[524]	1368	235.5
804	OUT[525]	1350	125.5
805	OUT[526]	1332	235.5
806	OUT[527]	1314	125.5
807	OUT[528]	1296	235.5
808	OUT[529]	1278	125.5
809	OUT[530]	1260	235.5
810	OUT[531]	1242	125.5
811	OUT[532]	1224	235.5
812	OUT[533]	1206	125.5
813	OUT[534]	1188	235.5
814	OUT[535]	1170	125.5
815	OUT[536]	1152	235.5
816	OUT[537]	1134	125.5
817	OUT[538]	1116	235.5
818	OUT[539]	1098	125.5
819	OUT[540]	1080	235.5
820	OUT[541]	1062	125.5
821	OUT[542]	1044	235.5
822	OUT[543]	1026	125.5
823	OUT[544]	1008	235.5
824	OUT[545]	990	125.5
825	OUT[546]	972	235.5
826	OUT[547]	954	125.5
827	OUT[548]	936	235.5
828	OUT[549]	918	125.5
829	OUT[550]	900	235.5
830	OUT[551]	882	125.5
831	OUT[552]	864	235.5
832	OUT[553]	846	125.5
833	OUT[554]	828	235.5
834	OUT[555]	810	125.5
835	OUT[556]	792	235.5
836	OUT[557]	774	125.5
837	OUT[558]	756	235.5
838	OUT[559]	738	125.5
839	OUT[560]	720	235.5
840	OUT[561]	702	125.5
841	OUT[562]	684	235.5
842	OUT[563]	666	125.5
843	OUT[564]	648	235.5
844	OUT[565]	630	125.5
845	OUT[566]	612	235.5
846	OUT[567]	594	125.5
847	OUT[568]	576	235.5
848	OUT[569]	558	125.5
849	OUT[570]	540	235.5
850	OUT[571]	522	125.5
851	OUT[572]	504	235.5
852	OUT[573]	486	125.5
853	OUT[574]	468	235.5
854	OUT[575]	450	125.5
855	OUT[576]	432	235.5
856	OUT[577]	414	125.5
857	OUT[578]	396	235.5
858	OUT[579]	378	125.5
859	OUT[580]	360	235.5
860	OUT[581]	342	125.5
861	OUT[582]	324	235.5
862	OUT[583]	306	125.5
863	OUT[584]	288	235.5
864	OUT[585]	270	125.5
865	OUT[586]	252	235.5
866	OUT[587]	234	125.5
867	OUT[588]	216	235.5
868	OUT[589]	198	125.5
869	OUT[590]	180	235.5
870	OUT[591]	162	125.5
871	OUT[592]	144	235.5
872	OUT[593]	126	125.5
873	OUT[594]	108	235.5
874	OUT[595]	90	125.5
875	OUT[596]	72	235.5
876	OUT[597]	54	125.5
877	OUT[598]	36	235.5
878	OUT[599]	18	125.5
879	OUT[600]	0	235.5
880	OUT[601]	-18	125.5

Pad #	Pad Name	Pad Coordinate	
		X	Y
881	OUT[602]	-36	235.5
882	OUT[603]	-54	125.5
883	OUT[604]	-72	235.5
884	OUT[605]	-90	125.5
885	OUT[606]	-108	235.5
886	OUT[607]	-126	125.5
887	OUT[608]	-144	235.5
888	OUT[609]	-162	125.5
889	OUT[610]	-180	235.5
890	OUT[611]	-198	125.5
891	OUT[612]	-216	235.5
892	OUT[613]	-234	125.5
893	OUT[614]	-252	235.5
894	OUT[615]	-270	125.5
895	OUT[616]	-288	235.5
896	OUT[617]	-306	125.5
897	OUT[618]	-324	235.5
898	OUT[619]	-342	125.5
899	OUT[620]	-360	235.5
900	OUT[621]	-378	125.5
901	OUT[622]	-396	235.5
902	OUT[623]	-414	125.5
903	OUT[624]	-432	235.5
904	OUT[625]	-450	125.5
905	OUT[626]	-468	235.5
906	OUT[627]	-486	125.5
907	OUT[628]	-504	235.5
908	OUT[629]	-522	125.5
909	OUT[630]	-540	235.5
910	OUT[631]	-558	125.5
911	OUT[632]	-576	235.5
912	OUT[633]	-594	125.5
913	OUT[634]	-612	235.5
914	OUT[635]	-630	125.5
915	OUT[636]	-648	235.5
916	OUT[637]	-666	125.5
917	OUT[638]	-684	235.5
918	OUT[639]	-702	125.5
919	OUT[640]	-720	235.5
920	OUT[641]	-738	125.5
921	OUT[642]	-756	235.5
922	OUT[643]	-774	125.5
923	OUT[644]	-792	235.5
924	OUT[645]	-810	125.5
925	OUT[646]	-828	235.5
926	OUT[647]	-846	125.5
927	OUT[648]	-864	235.5
928	OUT[649]	-882	125.5
929	OUT[650]	-900	235.5
930	OUT[651]	-918	125.5
931	OUT[652]	-936	235.5
932	OUT[653]	-954	125.5
933	OUT[654]	-972	235.5
934	OUT[655]	-990	125.5
935	OUT[656]	-1008	235.5
936	OUT[657]	-1026	125.5
937	OUT[658]	-1044	235.5
938	OUT[659]	-1062	125.5
939	OUT[660]	-1080	235.5
940	OUT[661]	-1098	125.5
941	OUT[662]	-1116	235.5
942	OUT[663]	-1134	125.5
943	OUT[664]	-1152	235.5
944	OUT[665]	-1170	125.5
945	OUT[666]	-1188	235.5
946	OUT[667]	-1206	125.5
947	OUT[668]	-1224	235.5
948	OUT[669]	-1242	125.5
949	OUT[670]	-1260	235.5
950	OUT[671]	-1278	125.5
951	OUT[672]	-1296	235.5
952	OUT[673]	-1314	125.5
953	OUT[674]	-1332	235.5
954	OUT[675]	-1350	125.5
955	OUT[676]	-1368	235.5
956	OUT[677]	-1386	125.5
957	OUT[678]	-1404	235.5
958	OUT[679]	-1422	125.5
959	OUT[680]	-1440	235.5
960	OUT[681]	-1458	125.5

Pad #	Pad Name	Pad Coordinate	
		X	Y
961	OUT[682]	-1476	235.5
962	OUT[683]	-1494	125.5
963	OUT[684]	-1512	235.5
964	OUT[685]	-1530	125.5
965	OUT[686]	-1548	235.5
966	OUT[687]	-1566	125.5
967	OUT[688]	-1584	235.5
968	OUT[689]	-1602	125.5
969	OUT[690]	-1620	235.5
970	OUT[691]	-1638	125.5
971	OUT[692]	-1656	235.5
972	OUT[693]	-1674	125.5
973	OUT[694]	-1692	235.5
974	OUT[695]	-1710	125.5
975	OUT[696]	-1728	235.5
976	OUT[697]	-1746	125.5
977	OUT[698]	-1764	235.5
978	OUT[699]	-1782	125.5
979	OUT[700]	-1800	235.5
980	OUT[701]	-1818	125.5
981	OUT[702]	-1836	235.5
982	OUT[703]	-1854	125.5
983	OUT[704]	-1872	235.5
984	OUT[705]	-1890	125.5
985	OUT[706]	-1908	235.5
986	OUT[707]	-1926	125.5
987	OUT[708]	-1944	235.5
988	OUT[709]	-1962	125.5
989	OUT[710]	-1980	235.5
990	OUT[711]	-1998	125.5
991	OUT[712]	-2016	235.5
992	OUT[713]	-2034	125.5
993	OUT[714]	-2052	235.5
994	OUT[715]	-2070	125.5
995	OUT[716]	-2088	235.5
996	OUT[717]	-2106	125.5
997	OUT[718]	-2124	235.5
998	OUT[719]	-2142	125.5
999	OUT[720]	-2160	235.5
1000	OUT[721]	-2178	125.5
1001	OUT[722]	-2196	235.5
1002	OUT[723]	-2214	125.5
1003	OUT[724]	-2232	235.5
1004	OUT[725]	-2250	125.5
1005	OUT[726]	-2268	235.5
1006	OUT[727]	-2286	125.5
1007	OUT[728]	-2304	235.5
1008	OUT[729]	-2322	125.5
1009	OUT[730]	-2340	235.5
1010	OUT[731]	-2358	125.5
1011	OUT[732]	-2376	235.5
1012	OUT[733]	-2394	125.5
1013	OUT[734]	-2412	235.5
1014	OUT[735]	-2430	125.5
1015	OUT[736]	-2448	235.5
1016	OUT[737]	-2466	125.5
1017	OUT[738]	-2484	235.5
1018	OUT[739]	-2502	125.5
1019	OUT[740]	-2520	235.5
1020	OUT[741]	-2538	125.5
1021	OUT[742]	-2556	235.5
1022	OUT[743]	-2574	125.5
1023	OUT[744]	-2592	235.5
1024	OUT[745]	-2610	125.5
1025	OUT[746]	-2628	235.5
1026	OUT[747]	-2646	125.5
1027	OUT[748]	-2664	235.5
1028	OUT[749]	-2682	125.5
1029	OUT[750]	-2700	235.5
1030	OUT[751]	-2718	125.5
1031	OUT[752]	-2736	235.5
1032	OUT[753]	-2754	125.5
1033	OUT[754]	-2772	235.5
1034	OUT[755]	-2790	125.5
1035	OUT[756]	-2808	235.5
1036	OUT[757]	-2826	125.5
1037	OUT[758]	-2844	235.5
1038	OUT[759]	-2862	125.5
1039	OUT[760]	-2880	235.5
1040	OUT[761]	-2898	125.5

Pad #	Pad Name	Pad Coordinate	
		X	Y
1041	OUT[762]	-2916	235.5
1042	OUT[763]	-2934	125.5
1043	OUT[764]	-2952	235.5
1044	OUT[765]	-2970	125.5
1045	OUT[766]	-2988	235.5
1046	OUT[767]	-3006	125.5
1047	OUT[768]	-3024	235.5
1048	OUT[769]	-3042	125.5
1049	OUT[770]	-3060	235.5
1050	OUT[771]	-3078	125.5
1051	OUT[772]	-3096	235.5
1052	OUT[773]	-3114	125.5
1053	OUT[774]	-3132	235.5
1054	OUT[775]	-3150	125.5
1055	OUT[776]	-3168	235.5
1056	OUT[777]	-3186	125.5
1057	OUT[778]	-3204	235.5
1058	OUT[779]	-3222	125.5
1059	OUT[780]	-3240	235.5
1060	OUT[781]	-3258	125.5
1061	OUT[782]	-3276	235.5
1062	OUT[783]	-3294	125.5
1063	OUT[784]	-3312	235.5
1064	OUT[785]	-3330	125.5
1065	OUT[786]	-3348	235.5
1066	OUT[787]	-3366	125.5
1067	OUT[788]	-3384	235.5
1068	OUT[789]	-3402	125.5
1069	OUT[790]	-3420	235.5
1070	OUT[791]	-3438	125.5
1071	OUT[792]	-3456	235.5
1072	OUT[793]	-3474	125.5
1073	OUT[794]	-3492	235.5
1074	OUT[795]	-3510	125.5
1075	OUT[796]	-3528	235.5
1076	OUT[797]	-3546	125.5
1077	OUT[798]	-3564	235.5
1078	OUT[799]	-3582	125.5
1079	OUT[800]	-3600	235.5
1080	OUT[801]	-3618	125.5
1081	OUT[802]	-3636	235.5
1082	OUT[803]	-3654	125.5
1083	OUT[804]	-3672	235.5
1084	OUT[805]	-3690	125.5
1085	OUT[806]	-3708	235.5
1086	OUT[807]	-3726	125.5
1087	OUT[808]	-3744	235.5
1088	OUT[809]	-3762	125.5
1089	OUT[810]	-3780	235.5
1090	OUT[811]	-3798	125.5
1091	OUT[812]	-3816	235.5
1092	OUT[813]	-3834	125.5
1093	OUT[814]	-3852	235.5
1094	OUT[815]	-3870	125.5
1095	OUT[816]	-3888	235.5
1096	OUT[817]	-3906	125.5
1097	OUT[818]	-3924	235.5
1098	OUT[819]	-3942	125.5
1099	OUT[820]	-3960	235.5
1100	OUT[821]	-3978	125.5
1101	OUT[822]	-3996	235.5
1102	OUT[823]	-4014	125.5
1103	OUT[824]	-4032	235.5
1104	OUT[825]	-4050	125.5
1105	OUT[826]	-4068	235.5
1106	OUT[827]	-4086	125.5
1107	OUT[828]	-4104	235.5
1108	OUT[829]	-4122	125.5
1109	OUT[830]	-4140	235.5
1110	OUT[831]	-4158	125.5
1111	OUT[832]	-4176	235.5
1112	OUT[833]	-4194	125.5
1113	OUT[834]	-4212	235.5
1114	OUT[835]	-4230	125.5
1115	OUT[836]	-4248	235.5
1116	OUT[837]	-4266	125.5
1117	OUT[838]	-4284	235.5
1118	OUT[839]	-4302	125.5
1119	OUT[840]	-4320	235.5
1120	OUT[841]	-4338	125.5

Pad #	Pad Name	Pad Coordinate	
		X	Y
1121	OUT[842]	-4356	235.5
1122	OUT[843]	-4374	125.5
1123	OUT[844]	-4392	235.5
1124	OUT[845]	-4410	125.5
1125	OUT[846]	-4428	235.5
1126	OUT[847]	-4446	125.5
1127	OUT[848]	-4464	235.5
1128	OUT[849]	-4482	125.5
1129	OUT[850]	-4500	235.5
1130	OUT[851]	-4518	125.5
1131	OUT[852]	-4536	235.5
1132	OUT[853]	-4554	125.5
1133	OUT[854]	-4572	235.5
1134	OUT[855]	-4590	125.5
1135	OUT[856]	-4608	235.5
1136	OUT[857]	-4626	125.5
1137	OUT[858]	-4644	235.5
1138	OUT[859]	-4662	125.5
1139	OUT[860]	-4680	235.5
1140	OUT[861]	-4698	125.5
1141	OUT[862]	-4716	235.5
1142	OUT[863]	-4734	125.5
1143	OUT[864]	-4752	235.5
1144	OUT[865]	-4770	125.5
1145	OUT[866]	-4788	235.5
1146	OUT[867]	-4806	125.5
1147	OUT[868]	-4824	235.5
1148	OUT[869]	-4842	125.5
1149	OUT[870]	-4860	235.5
1150	OUT[871]	-4878	125.5
1151	OUT[872]	-4896	235.5
1152	OUT[873]	-4914	125.5
1153	OUT[874]	-4932	235.5
1154	OUT[875]	-4950	125.5
1155	OUT[876]	-4968	235.5
1156	OUT[877]	-4986	125.5
1157	OUT[878]	-5004	235.5
1158	OUT[879]	-5022	125.5
1159	OUT[880]	-5040	235.5
1160	OUT[881]	-5058	125.5
1161	OUT[882]	-5076	235.5
1162	OUT[883]	-5094	125.5
1163	OUT[884]	-5112	235.5
1164	OUT[885]	-5130	125.5
1165	OUT[886]	-5148	235.5
1166	OUT[887]	-5166	125.5
1167	OUT[888]	-5184	235.5
1168	OUT[889]	-5202	125.5
1169	OUT[890]	-5220	235.5
1170	OUT[891]	-5238	125.5
1171	OUT[892]	-5256	235.5
1172	OUT[893]	-5274	125.5
1173	OUT[894]	-5292	235.5
1174	OUT[895]	-5310	125.5
1175	OUT[896]	-5328	235.5
1176	OUT[897]	-5346	125.5
1177	OUT[898]	-5364	235.5
1178	OUT[899]	-5382	125.5
1179	OUT[900]	-5400	235.5
1180	OUT[901]	-5418	125.5
1181	OUT[902]	-5436	235.5
1182	OUT[903]	-5454	125.5
1183	OUT[904]	-5472	235.5
1184	OUT[905]	-5490	125.5
1185	OUT[906]	-5508	235.5
1186	OUT[907]	-5526	125.5
1187	OUT[908]	-5544	235.5
1188	OUT[909]	-5562	125.5
1189	OUT[910]	-5580	235.5
1190	OUT[911]	-5598	125.5
1191	OUT[912]	-5616	235.5
1192	OUT[913]	-5634	125.5
1193	OUT[914]	-5652	235.5
1194	OUT[915]	-5670	125.5
1195	OUT[916]	-5688	235.5
1196	OUT[917]	-5706	125.5
1197	OUT[918]	-5724	235.5
1198	OUT[919]	-5742	125.5
1199	OUT[920]	-5760	235.5
1200	OUT[921]	-5778	125.5

Pad #	Pad Name	Pad Coordinate	
		X	Y
1201	OUT[922]	-5796	235.5
1202	OUT[923]	-5814	125.5
1203	OUT[924]	-5832	235.5
1204	OUT[925]	-5850	125.5
1205	OUT[926]	-5868	235.5
1206	OUT[927]	-5886	125.5
1207	OUT[928]	-5904	235.5
1208	OUT[929]	-5922	125.5
1209	OUT[930]	-5940	235.5
1210	OUT[931]	-5958	125.5
1211	OUT[932]	-5976	235.5
1212	OUT[933]	-5994	125.5
1213	OUT[934]	-6012	235.5
1214	OUT[935]	-6030	125.5
1215	OUT[936]	-6048	235.5
1216	OUT[937]	-6066	125.5
1217	OUT[938]	-6084	235.5
1218	OUT[939]	-6102	125.5
1219	OUT[940]	-6120	235.5
1220	OUT[941]	-6138	125.5
1221	OUT[942]	-6156	235.5
1222	OUT[943]	-6174	125.5
1223	OUT[944]	-6192	235.5
1224	OUT[945]	-6210	125.5
1225	OUT[946]	-6228	235.5
1226	OUT[947]	-6246	125.5
1227	OUT[948]	-6264	235.5
1228	OUT[949]	-6282	125.5
1229	OUT[950]	-6300	235.5
1230	OUT[951]	-6318	125.5
1231	OUT[952]	-6336	235.5
1232	OUT[953]	-6354	125.5
1233	OUT[954]	-6372	235.5
1234	OUT[955]	-6390	125.5
1235	OUT[956]	-6408	235.5
1236	OUT[957]	-6426	125.5
1237	OUT[958]	-6444	235.5
1238	OUT[959]	-6462	125.5
1239	OUT[960]	-6480	235.5
1240	OUT[961]	-6498	125.5
1241	OUT[962]	-6516	235.5
1242	OUT[963]	-6534	125.5
1243	OUT[964]	-6552	235.5
1244	OUT[965]	-6570	125.5
1245	OUT[966]	-6588	235.5
1246	OUT[967]	-6606	125.5
1247	OUT[968]	-6624	235.5
1248	OUT[969]	-6642	125.5
1249	OUT[970]	-6660	235.5
1250	OUT[971]	-6678	125.5
1251	OUT[972]	-6696	235.5
1252	OUT[973]	-6714	125.5
1253	OUT[974]	-6732	235.5
1254	OUT[975]	-6750	125.5
1255	OUT[976]	-6768	235.5
1256	OUT[977]	-6786	125.5
1257	OUT[978]	-6804	235.5
1258	OUT[979]	-6822	125.5
1259	OUT[980]	-6840	235.5
1260	OUT[981]	-6858	125.5
1261	OUT[982]	-6876	235.5
1262	OUT[983]	-6894	125.5
1263	OUT[984]	-6912	235.5
1264	OUT[985]	-6930	125.5
1265	OUT[986]	-6948	235.5
1266	OUT[987]	-6966	125.5
1267	OUT[988]	-6984	235.5
1268	OUT[989]	-7002	125.5
1269	OUT[990]	-7020	235.5
1270	OUT[991]	-7038	125.5
1271	OUT[992]	-7056	235.5
1272	OUT[993]	-7074	125.5
1273	OUT[994]	-7092	235.5
1274	OUT[995]	-7110	125.5
1275	OUT[996]	-7128	235.5
1276	OUT[997]	-7146	125.5
1277	OUT[998]	-7164	235.5
1278	OUT[999]	-7182	125.5
1279	OUT[1000]	-7200	235.5
1280	OUT[1001]	-7218	125.5

Pad #	Pad Name	Pad Coordinate	
		X	Y
1281	OUT[1002]	-7236	235.5
1282	OUT[1003]	-7254	125.5
1283	OUT[1004]	-7272	235.5
1284	OUT[1005]	-7290	125.5
1285	OUT[1006]	-7308	235.5
1286	OUT[1007]	-7326	125.5
1287	OUT[1008]	-7344	235.5
1288	OUT[1009]	-7362	125.5
1289	OUT[1010]	-7380	235.5
1290	OUT[1011]	-7398	125.5
1291	OUT[1012]	-7416	235.5
1292	OUT[1013]	-7434	125.5
1293	OUT[1014]	-7452	235.5
1294	OUT[1015]	-7470	125.5
1295	OUT[1016]	-7488	235.5
1296	OUT[1017]	-7506	125.5
1297	OUT[1018]	-7524	235.5
1298	OUT[1019]	-7542	125.5
1299	OUT[1020]	-7560	235.5
1300	OUT[1021]	-7578	125.5
1301	OUT[1022]	-7596	235.5
1302	OUT[1023]	-7614	125.5
1303	OUT[1024]	-7632	235.5
1304	OUT[1025]	-7650	125.5
1305	OUT[1026]	-7668	235.5
1306	OUT[1027]	-7686	125.5
1307	OUT[1028]	-7704	235.5
1308	OUT[1029]	-7722	125.5
1309	OUT[1030]	-7740	235.5
1310	OUT[1031]	-7758	125.5
1311	OUT[1032]	-7776	235.5
1312	OUT[1033]	-7794	125.5
1313	OUT[1034]	-7812	235.5
1314	OUT[1035]	-7830	125.5
1315	OUT[1036]	-7848	235.5
1316	OUT[1037]	-7866	125.5
1317	OUT[1038]	-7884	235.5
1318	OUT[1039]	-7902	125.5
1319	OUT[1040]	-7920	235.5
1320	OUT[1041]	-7938	125.5
1321	OUT[1042]	-7956	235.5
1322	OUT[1043]	-7974	125.5
1323	OUT[1044]	-7992	235.5
1324	OUT[1045]	-8010	125.5
1325	OUT[1046]	-8028	235.5
1326	OUT[1047]	-8046	125.5
1327	OUT[1048]	-8064	235.5
1328	OUT[1049]	-8082	125.5
1329	OUT[1050]	-8100	235.5
1330	OUT[1051]	-8118	125.5
1331	OUT[1052]	-8136	235.5
1332	OUT[1053]	-8154	125.5
1333	OUT[1054]	-8172	235.5
1334	OUT[1055]	-8190	125.5
1335	OUT[1056]	-8208	235.5
1336	OUT[1057]	-8226	125.5
1337	OUT[1058]	-8244	235.5
1338	OUT[1059]	-8262	125.5
1339	OUT[1060]	-8280	235.5
1340	OUT[1061]	-8298	125.5
1341	OUT[1062]	-8316	235.5
1342	OUT[1063]	-8334	125.5
1343	OUT[1064]	-8352	235.5
1344	OUT[1065]	-8370	125.5
1345	OUT[1066]	-8388	235.5
1346	OUT[1067]	-8406	125.5
1347	OUT[1068]	-8424	235.5
1348	OUT[1069]	-8442	125.5
1349	OUT[1070]	-8460	235.5
1350	OUT[1071]	-8478	125.5
1351	OUT[1072]	-8496	235.5
1352	OUT[1073]	-8514	125.5
1353	OUT[1074]	-8532	235.5
1354	OUT[1075]	-8550	125.5
1355	OUT[1076]	-8568	235.5
1356	OUT[1077]	-8586	125.5
1357	OUT[1078]	-8604	235.5
1358	OUT[1079]	-8622	125.5
1359	OUT[1080]	-8640	235.5
1360	OUT[1081]	-8658	125.5

Pad #	Pad Name	Pad Coordinate	
		X	Y
1361	OUT[1082]	-8676	235.5
1362	OUT[1083]	-8694	125.5
1363	OUT[1084]	-8712	235.5
1364	OUT[1085]	-8730	125.5
1365	OUT[1086]	-8748	235.5
1366	OUT[1087]	-8766	125.5
1367	OUT[1088]	-8784	235.5
1368	OUT[1089]	-8802	125.5
1369	OUT[1090]	-8820	235.5
1370	OUT[1091]	-8838	125.5
1371	OUT[1092]	-8856	235.5
1372	OUT[1093]	-8874	125.5
1373	OUT[1094]	-8892	235.5
1374	OUT[1095]	-8910	125.5
1375	OUT[1096]	-8928	235.5
1376	OUT[1097]	-8946	125.5
1377	OUT[1098]	-8964	235.5
1378	OUT[1099]	-8982	125.5
1379	OUT[1100]	-9000	235.5
1380	OUT[1101]	-9018	125.5
1381	OUT[1102]	-9036	235.5
1382	OUT[1103]	-9054	125.5
1383	OUT[1104]	-9072	235.5
1384	OUT[1105]	-9090	125.5
1385	OUT[1106]	-9108	235.5
1386	OUT[1107]	-9126	125.5
1387	OUT[1108]	-9144	235.5
1388	OUT[1109]	-9162	125.5
1389	OUT[1110]	-9180	235.5
1390	OUT[1111]	-9198	125.5
1391	OUT[1112]	-9216	235.5
1392	OUT[1113]	-9234	125.5
1393	OUT[1114]	-9252	235.5
1394	OUT[1115]	-9270	125.5
1395	OUT[1116]	-9288	235.5
1396	OUT[1117]	-9306	125.5
1397	OUT[1118]	-9324	235.5
1398	OUT[1119]	-9342	125.5
1399	OUT[1120]	-9360	235.5
1400	OUT[1121]	-9378	125.5
1401	OUT[1122]	-9396	235.5
1402	OUT[1123]	-9414	125.5
1403	OUT[1124]	-9432	235.5
1404	OUT[1125]	-9450	125.5
1405	OUT[1126]	-9468	235.5
1406	OUT[1127]	-9486	125.5
1407	OUT[1128]	-9504	235.5
1408	OUT[1129]	-9522	125.5
1409	OUT[1130]	-9540	235.5
1410	OUT[1131]	-9558	125.5
1411	OUT[1132]	-9576	235.5
1412	OUT[1133]	-9594	125.5
1413	OUT[1134]	-9612	235.5
1414	OUT[1135]	-9630	125.5
1415	OUT[1136]	-9648	235.5
1416	OUT[1137]	-9666	125.5
1417	OUT[1138]	-9684	235.5
1418	OUT[1139]	-9702	125.5
1419	OUT[1140]	-9720	235.5
1420	OUT[1141]	-9738	125.5
1421	OUT[1142]	-9756	235.5
1422	OUT[1143]	-9774	125.5
1423	OUT[1144]	-9792	235.5
1424	OUT[1145]	-9810	125.5
1425	OUT[1146]	-9828	235.5
1426	OUT[1147]	-9846	125.5
1427	OUT[1148]	-9864	235.5
1428	OUT[1149]	-9882	125.5
1429	OUT[1150]	-9900	235.5
1430	OUT[1151]	-9918	125.5
1431	OUT[1152]	-9936	235.5
1432	OUT[1153]	-9954	125.5
1433	OUT[1154]	-9972	235.5
1434	OUT[1155]	-9990	125.5
1435	OUT[1156]	-10008	235.5
1436	OUT[1157]	-10026	125.5
1437	OUT[1158]	-10044	235.5
1438	OUT[1159]	-10062	125.5
1439	OUT[1160]	-10080	235.5
1440	OUT[1161]	-10098	125.5



Pad #	Pad Name	Pad Coordinate	
		X	Y
1441	OUT[1162]	-10116	235.5
1442	OUT[1163]	-10134	125.5
1443	OUT[1164]	-10152	235.5
1444	OUT[1165]	-10170	125.5
1445	OUT[1166]	-10188	235.5
1446	OUT[1167]	-10206	125.5
1447	OUT[1168]	-10224	235.5
1448	OUT[1169]	-10242	125.5
1449	OUT[1170]	-10260	235.5
1450	OUT[1171]	-10278	125.5
1451	OUT[1172]	-10296	235.5
1452	OUT[1173]	-10314	125.5
1453	OUT[1174]	-10332	235.5
1454	OUT[1175]	-10350	125.5
1455	OUT[1176]	-10368	235.5
1456	OUT[1177]	-10386	125.5
1457	OUT[1178]	-10404	235.5
1458	OUT[1179]	-10422	125.5
1459	OUT[1180]	-10440	235.5
1460	OUT[1181]	-10458	125.5
1461	OUT[1182]	-10476	235.5
1462	OUT[1183]	-10494	125.5
1463	OUT[1184]	-10512	235.5
1464	OUT[1185]	-10530	125.5
1465	OUT[1186]	-10548	235.5
1466	OUT[1187]	-10566	125.5
1467	OUT[1188]	-10584	235.5
1468	OUT[1189]	-10602	125.5
1469	OUT[1190]	-10620	235.5
1470	OUT[1191]	-10638	125.5
1471	OUT[1192]	-10656	235.5
1472	OUT[1193]	-10674	125.5
1473	OUT[1194]	-10692	235.5
1474	OUT[1195]	-10710	125.5
1475	OUT[1196]	-10728	235.5
1476	OUT[1197]	-10746	125.5
1477	OUT[1198]	-10764	235.5
1478	OUT[1199]	-10782	125.5
1479	OUT[1200]	-10800	235.5
1480	OUT[1201]	-10818	125.5
1481	PATN3L	-10836	235.5
1482	XONL	-11283	262
1483	XONR	-11373	262
1484	F_CTRL_L	-11463	262
1485	F_CTRL_R	-11553	262
1486	AL_MARK_L	-11101.5	220.5
1487	AL_MARK_R	11101.5	220.5

**9. DEFINITIONS****9.1 Data Sheet Status**

Preliminary Data Sheet	This data sheet contains preliminary data; supplementary data may be published later.
Data Sheet	This data sheet contains final product specifications.

Contents in the document are subject to change without notice.

**9.2 Life Support Application**

These products are not designed for use in life support appliances, devices, or systems where malfunction of these products can reasonably be expected to result in personal injury. fitipower customers using or selling these products for use in such applications do so at their own risk and agree to fully indemnify fitipower for any damages resulting from such improper use or sale.

**10 REVISION HISTORY**

Revision	Content	Page	Date
1.0	New Issue		2012/11/07