



# >> DATA SHEET

(DOC No. HX8678-C-DS)

## >> HX8678-C

480CH TFT LCD Gate Driver

Version 07 January, 2017

**Himax Technologies, Inc.**

<http://www.himax.com.tw>

» HX8678-C  
480CH TFT LCD Gate Driver



Himax Technologies, Inc.  
http://www.himax.com.tw

Revision History

January, 2017

Version	Date	Description of changes
01	2011/06/02	New setup.
	2011/07/20	Page 6 1. Modify MODE[3:1] default setting.
	2011/08/26	Page 4, 8, 13 1. Add power off reset related data.
02	2012/03/30	All pages 1. Remove "preliminary" wording from the data sheet.
		Page 13 2. Modify max. VDD from 7.0V to 6.0V at absolute maximum ratings, from 5.5V to 5.0V at recommended operating conditions.
03	2012/05/21	Page 16 3. Modify bump height from 15±3µm to 12±3µm or 9±2µm.
		Page 4 1. Modify max. digital supply voltage from 5.5V to 5.0V.
04	2012/08/20	Page 16 2. Modify wording VEE to VGL at section 9.1 HX8678-C gate driver bump location.
		Page 8 1. Remove the structure figure of slow gate off function.
05	2013/11/15	Page 7 1. Modify VGN pin description.
	2013/12/30	Page 13 2. Modify min/max VGN spec. at section 6.1 absolute maximum rating from -0.3V/+42V to VGL+3V/VGH. 3. Modify min VGN spec. at section 6.2 recommended operating conditions from 0V to VGL+4V.
06		2014/02/06
	Page 16, 17 1. Correct bump shape for Bump No. 485 and No. 659.	
07	2015/08/12	Page 4, 13 1. Modify min. digital supply voltage from 2.7V to 1.7V.
	2017/01/03	Page 7, 13 2. Update GPM output waveform and application circuit. Page 13 1. Modify operation temperature at section 6.2 recommended operating conditions from -40~+95 to -20~+85.

<b>1. General Description</b> .....	<b>4</b>
<b>2. Features</b> .....	<b>4</b>
<b>3. Block Diagram</b> .....	<b>5</b>
<b>4. Pin Description</b> .....	<b>6</b>
<b>5. Function Description</b> .....	<b>8</b>
5.1 Device operation .....	8
5.2 Device power level.....	12
5.3 Power on/off sequence .....	12
<b>6. DC Characteristics</b> .....	<b>13</b>
6.1 Absolute maximum rating (VSS=0V).....	13
6.2 Recommended operating conditions (VSS=0V).....	13
6.3 Electrical characteristics (VSS=0V).....	13
<b>7. AC Characteristics</b> .....	<b>14</b>
<b>8. Waveform</b> .....	<b>15</b>
<b>9. Pad Coordinates</b> .....	<b>16</b>
9.1 HX8678-C gate driver bump location.....	16
9.2 Bump outline dimensions.....	17
9.3 Alignment mark.....	17
9.4 Bump center coordinates.....	18
9.5 Alignment mark center coordinates.....	24
<b>10. Ordering Information</b> .....	<b>25</b>

Himax Confidential  
Do Not Copy

## 1. General Description

The HX8678-C is a 480-channel outputs gate driver, which is used for driving the gate line of TFT LCD panel. It is designed for 2-level output with 40V LCD driving voltage range.

## 2. Features

- 2-level output
- 480/450/320/272/240/220/160/120 channel outputs selectable with 2 dummy outputs
- Maximum 200KHz operation frequency
- Digital supply voltage: 1.7V to 5.0V
- LCD driving voltage range: 40V
- Bi-directional data shift capability
- Slow gate off function control by VGN
- Embedded with power off reset circuit
- High voltage CMOS process technology
- COG/COF package

Himax Confidential  
Do Not Copy

### 3. Block Diagram

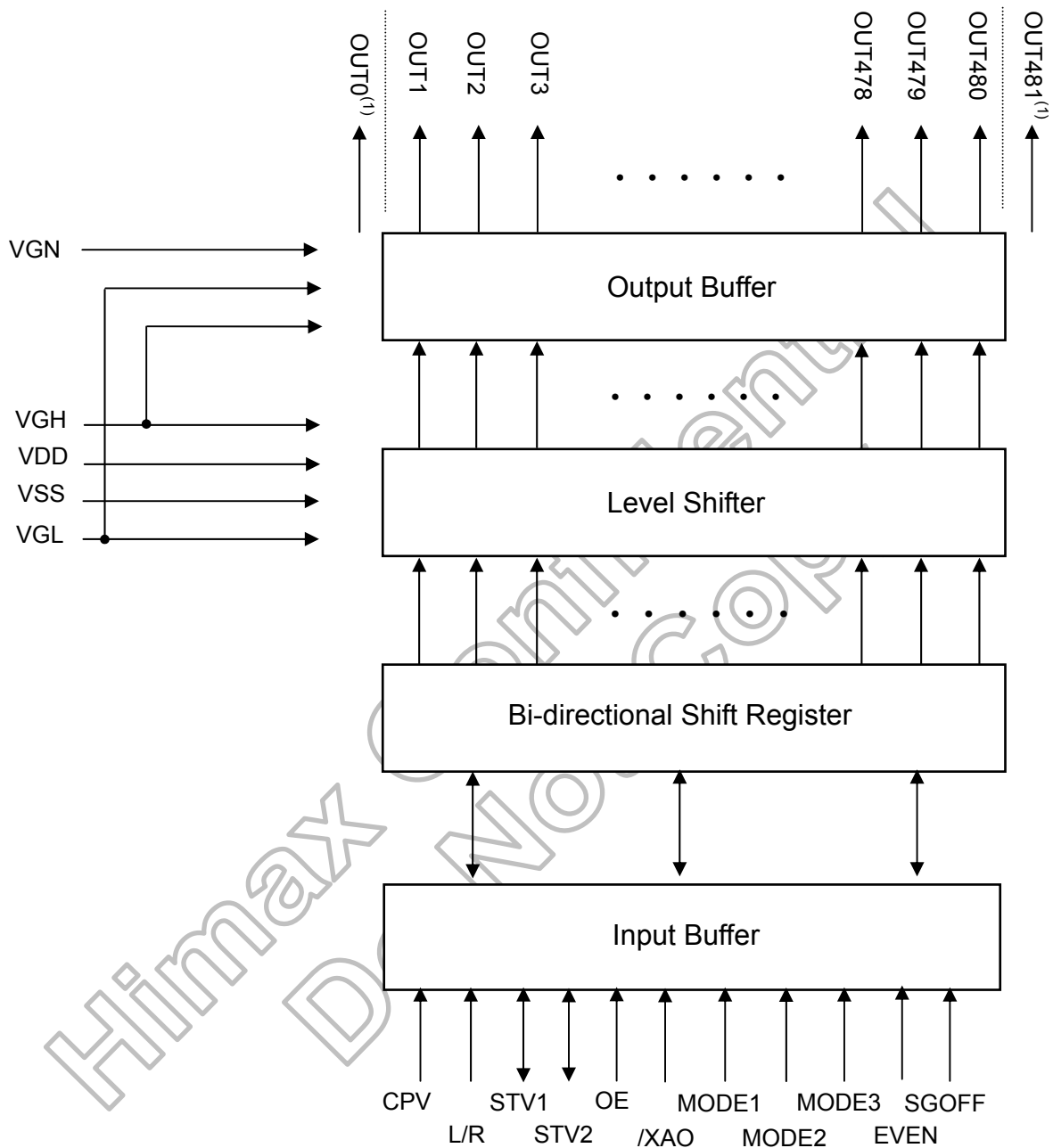

**Note:** (1) OUT0 and OUT481 are LCD panel auxiliary pins, these pins always output VGL level.

### 4. Pin Description

Pin name	Type	Function	Description																																													
CPV	In	Shift clock input	The clock for the internal shift registers.																																													
L/R	In	<b>Shift direction control pin</b>	The shift direction of device internal shift register is controlled by this pin as shown below: L/R=H: STV1→OUT1→OUT2→...→OUT480→STV2. L/R=L: STV2→OUT480→...→OUT2→OUT1→STV1.																																													
STV1 STV2	In/ Out	Start pulse input/output pin	L/R=H, STV1 is used for start pulse input; STV2 is used for start pulse output. L/R=L, STV2 is used for start pulse input; STV1 is used for start pulse output.																																													
OE	In	Output enable control	The OE signal control the output enable. OE=H: All driver outputs are fixed to VGL regardless of CPV. However, the content of shift register is not cleared. OE=L: Normal operation.																																													
EVEN	In	<b>Output turn-on sequence control</b>	The pin controls the driver outputs sequence. EVEN is pulled low to VSS internally. When it is not used, connecting to VSS is recommended.																																													
/XAO	In	Output all-on control	When /XAO is set to L, all outputs are fixed to VGH. Note that this pin has higher priority than OE. However, the content of shift register is not cleared. /XAO is pulled high to VDD internally. When it is not used, connecting to VDD is recommended.																																													
MODE1 MODE2 MODE3	In	<b>Channel mode selection</b>	Channel mode selection, default MODE1=L, MODE2=L, MODE3=L. <table border="1" style="margin-left: auto; margin-right: auto;"> <thead> <tr> <th>Output channel</th> <th>Disable channel</th> <th>MODE1</th> <th>MODE2</th> <th>MODE3</th> </tr> </thead> <tbody> <tr> <td>120</td> <td>61~420</td> <td>L</td> <td>L</td> <td>L</td> </tr> <tr> <td>160</td> <td>81~400</td> <td>L</td> <td>L</td> <td>H</td> </tr> <tr> <td>220</td> <td>111~370</td> <td>L</td> <td>H</td> <td>L</td> </tr> <tr> <td>240</td> <td>121~360</td> <td>L</td> <td>H</td> <td>H</td> </tr> <tr> <td>272</td> <td>137~344</td> <td>H</td> <td>L</td> <td>L</td> </tr> <tr> <td>320</td> <td>161~320</td> <td>H</td> <td>L</td> <td>H</td> </tr> <tr> <td>450</td> <td>226~255</td> <td>H</td> <td>H</td> <td>L</td> </tr> <tr> <td>480</td> <td>-</td> <td>H</td> <td>H</td> <td>H</td> </tr> </tbody> </table>	Output channel	Disable channel	MODE1	MODE2	MODE3	120	61~420	L	L	L	160	81~400	L	L	H	220	111~370	L	H	L	240	121~360	L	H	H	272	137~344	H	L	L	320	161~320	H	L	H	450	226~255	H	H	L	480	-	H	H	H
Output channel	Disable channel	MODE1	MODE2	MODE3																																												
120	61~420	L	L	L																																												
160	81~400	L	L	H																																												
220	111~370	L	H	L																																												
240	121~360	L	H	H																																												
272	137~344	H	L	L																																												
320	161~320	H	L	H																																												
450	226~255	H	H	L																																												
480	-	H	H	H																																												
SGOFF	In	<b>Slow gate off enable control</b>	The SGOFF signal controls the slow gate off enable. SGOFF=H: Slow gate off enable, output H duty is same as CPV H duty. SGOFF=L or open: Normal operation. SGOFF is pulled low to VSS internally. When it is not used, connecting to VSS is recommended.																																													
OUT1 ~ OUT480	Out	Driver output	The output is either VGH or VGL for driving the gate line of TFT LCD panel.																																													
OUT0 OUT481	Out	Auxiliary pins	These two pins always output VGL level.																																													
VDD	In	Power supply	Digital power supply.																																													
VSS	In	Power supply	Grounding for VDD.																																													
VGH	In	Power supply	Power supply for Gate on output.																																													
VGL	In	Power supply	Power supply for Gate off output.																																													
PATH	In	Internal link	Linked together internal.																																													

Pin name	Type	Function	Description									
VGN	In	Power supply	Slow gate off function control pin. When slow gate off is disabled, connecting VGN to VDD is forbidden, connecting VGN to VSS, VGL or VGH, or keeping it floating is recommended.									
			<table border="1"> <thead> <tr> <th>VGN</th> <th>Gate off slew rate</th> </tr> </thead> <tbody> <tr> <td>VGN=VGH</td> <td>Strongest</td> </tr> <tr> <td>⋮</td> <td>⋮</td> </tr> <tr> <td>↑</td> <td>↑</td> </tr> <tr> <td>⋮</td> <td>⋮</td> </tr> <tr> <td>VGN=VGL+4V</td> <td>Weakest</td> </tr> </tbody> </table>	VGN	Gate off slew rate	VGN=VGH	Strongest	⋮	⋮	↑	↑	⋮
VGN	Gate off slew rate											
VGN=VGH	Strongest											
⋮	⋮											
↑	↑											
⋮	⋮											
VGN=VGL+4V	Weakest											

GPM Output Waveform

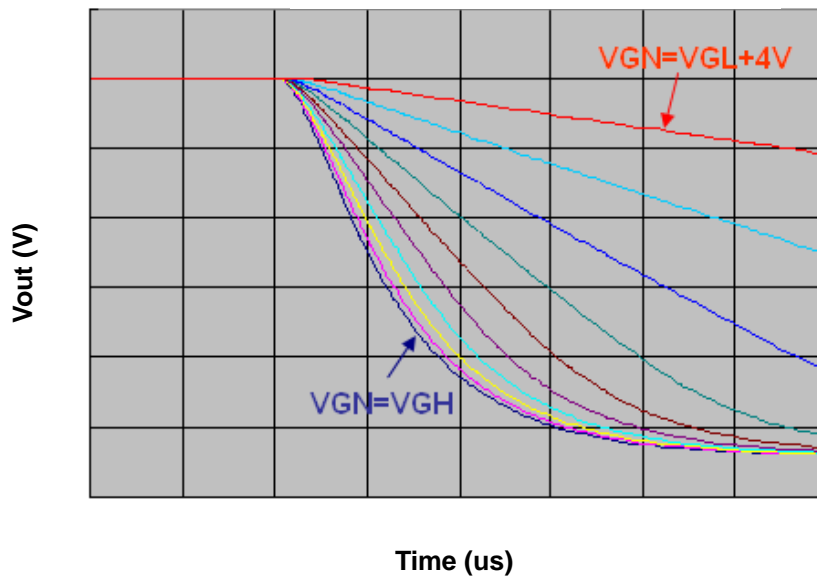

GPM application circuit:

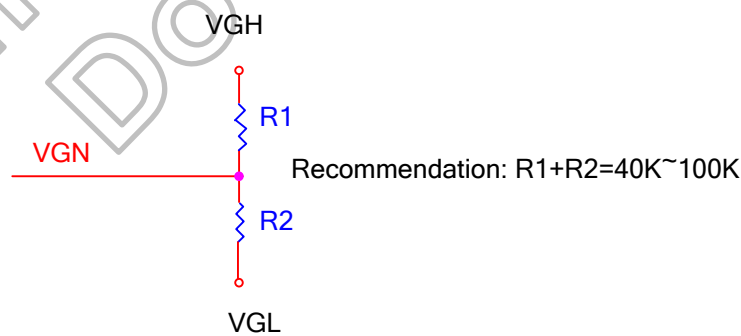

## 5. Function Description

### 5.1 Device operation

When L/R=H, MODE1=H, MODE2=H, MODE3=H, EVEN=L, and SGOFF=L, the STV1 start pulse input is sensed on the rising edge of CPV and stored in the first stage of shift register, which makes the first scan signal output from the OUT1 pin. While stored data is transferred to the next stage shift register on the rising edge of next CPV, new data of STV1 is sensed and stored simultaneously.

The output pin (**OUT1 to OUT480**) supplies VGH voltage or VGL voltage to the LCD panel depending on the data stored in the shift register. For normal operation, a VGH voltage is outputted one by one from OUT1 to OUT480 in synchronization with CPV pulse.

After 480<sup>th</sup> CPV rising edge, the STV2 goes up to high level on the 480<sup>th</sup> falling edge of CPV and goes down to low level on the 481<sup>st</sup> falling edge of CPV. This STV2 output signal becomes the STV1 start pulse input of next cascaded gate driver.

Generally, GPM (**Gate pulse modulation**) is used to reduce the influence of the feed through caused by the gate driver output falling. However, GPM consumes much power because of the large parasitic capacitance over VGH power trace. The HX8678-C supports slow gate off function to replace GPM function. When SGOFF=H, CPV=L and OE=L, the output NMOS pulls the scan line to VGL level, and VGN can control the falling rate of the output voltage to obtain slow gate off function. When OE=H, the corresponding output channels are drove to VGL level regardless of CPV state and VGH controls the falling rate. It can reduce the feed through influence and the power consumption is much lower than GPM.

The HX8678-C is embedded with a power off reset circuit. When VDD drops below the threshold voltage  $V_{POFF}$ , the internal /XAO will be "L" regardless of the external /XAO input, it makes all outputs rise to VGH level to reduce possible power off image residue.



**A. Example of input/output timing (MODE1=H, MODE2=H, MODE3=H, L/R=H, EVEN=L, SGOFF=L)**

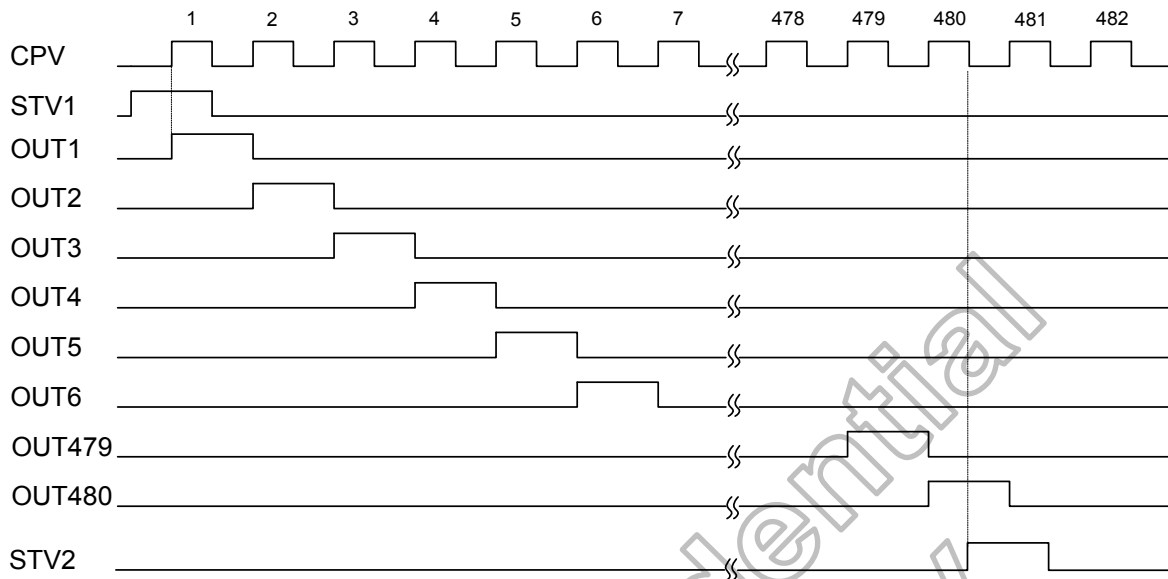

**B. Example of input/output timing (MODE1=H, MODE2=H, MODE3=H, L/R=H, EVEN=H, SGOFF=L)**

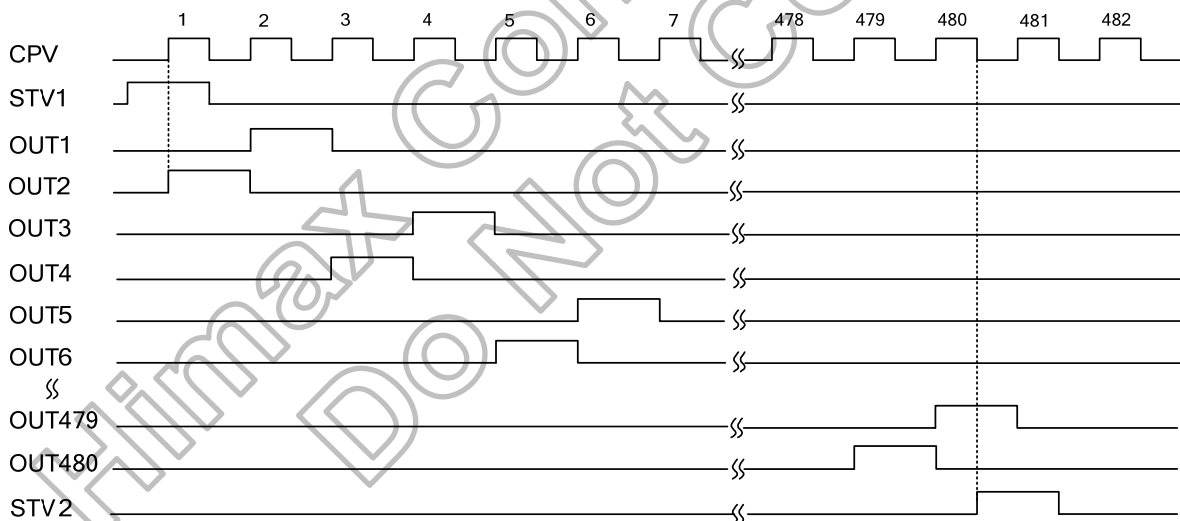

**C. Example of input/output timing (MODE1=H, MODE2=H, MODE3=H, L/R=L, EVEN=L, SGOFF=L)**

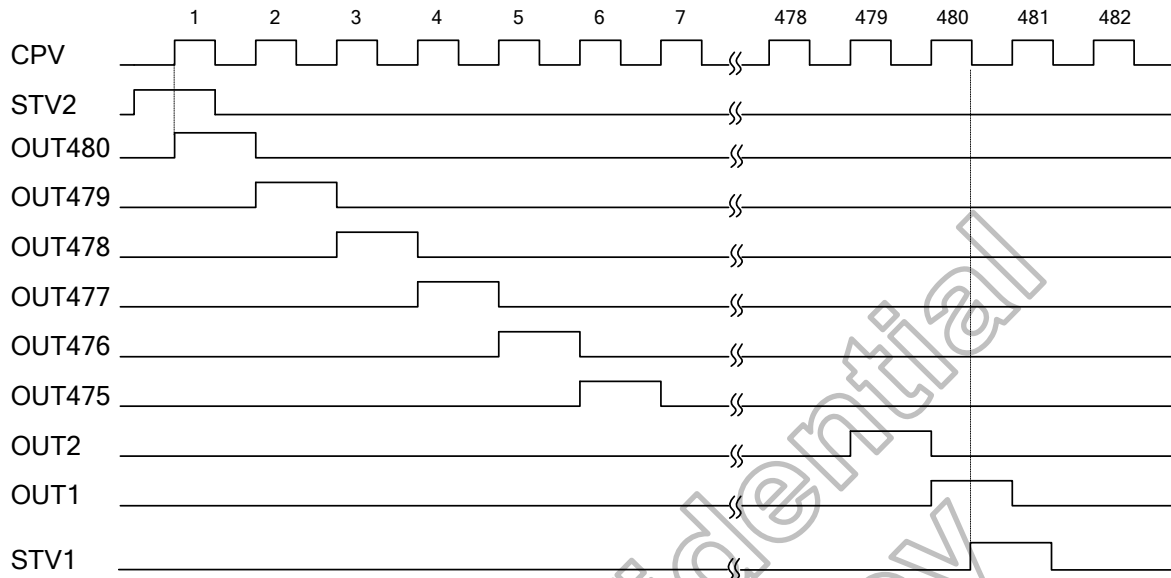

**D. Example of input/output timing (MODE1=H, MODE2=H, MODE3=H, L/R=L, EVEN=H, SGOFF=L)**

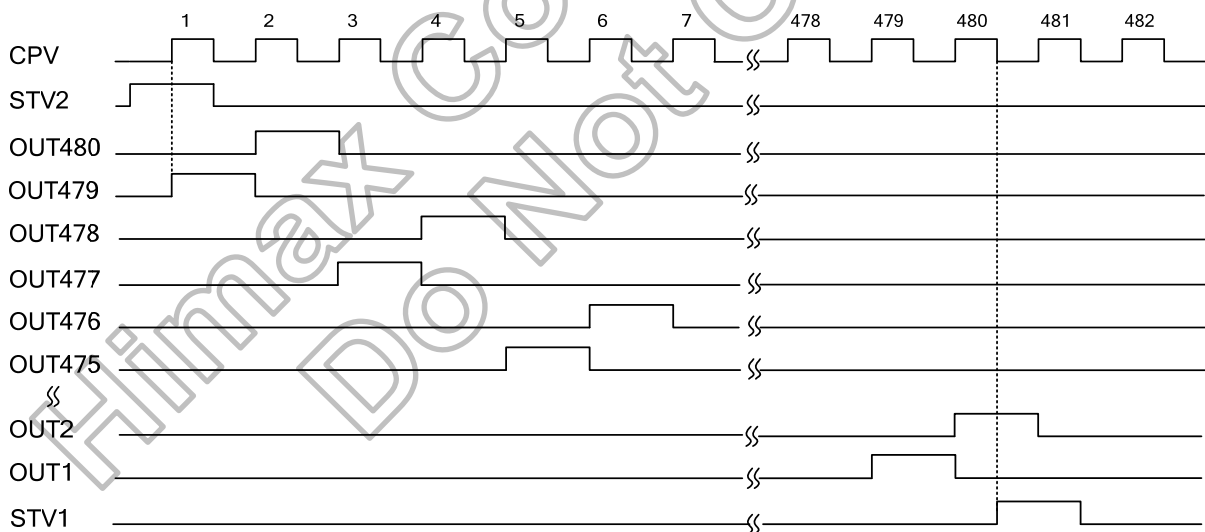

**E. Example of input/output timing (MODE1=H, MODE2=H, MODE3=H, L/R=H, EVEN=L, SGOFF=L with OE & /XAO)**

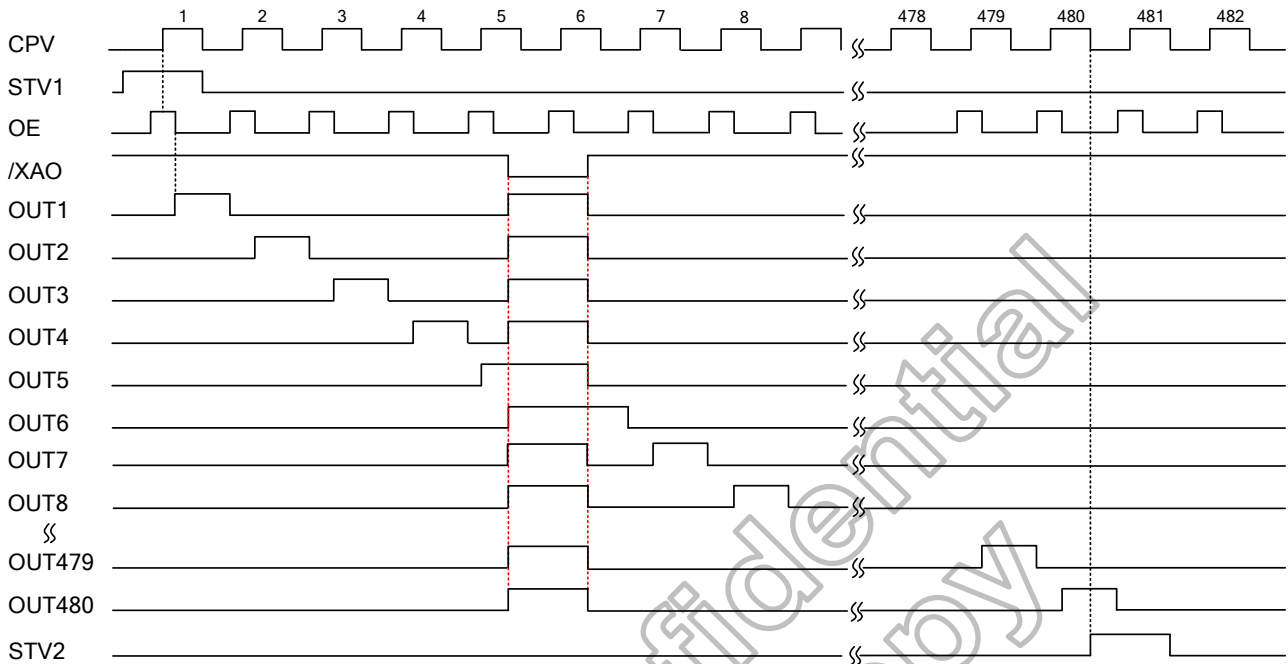

**F. Example of input/output timing (MODE1=H, MODE2=H, MODE3=H, L/R=H, EVEN=L, SGOFF=H with OE & /XAO)**

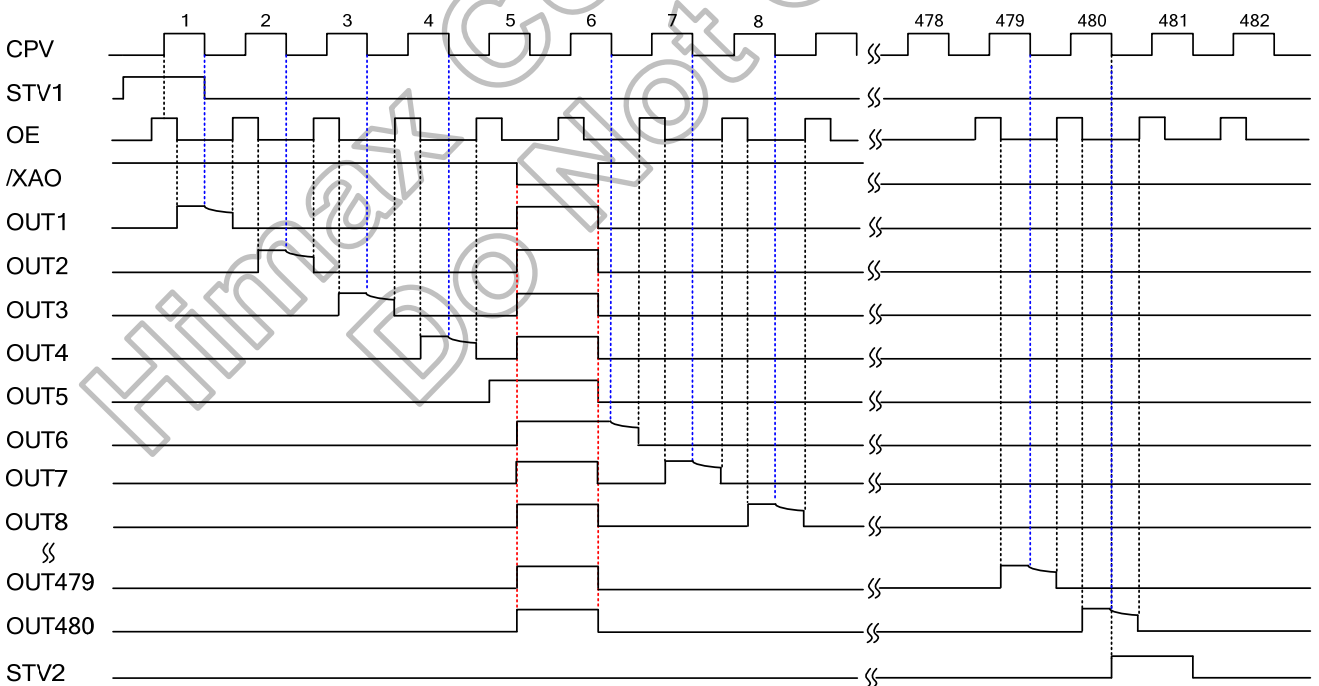

### 5.2 Device power level

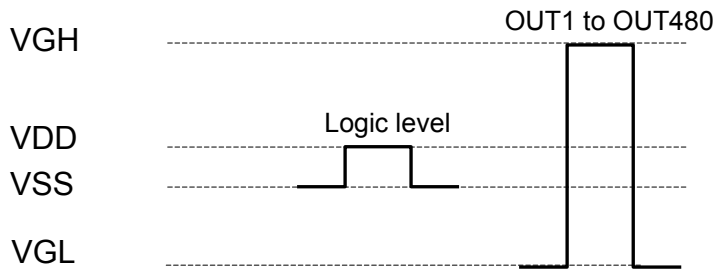

The logic levels of CPV, L/R, OE, /XAO, MODE1, MODE2, MODE3, EVEN, SGOFF, STV1 and STV2 have to swing between VDD for “H” and VSS for “L”.

### 5.3 Power on/off sequence

The power on/off sequence need be followed as shown below.

When power on, VGH/VGL can start to be turned on after VDD reaches 1.6V. When VGH/VGL start to be turned on, CPV and STV should be not floating, and /XAO should be at VDD level or floating. The other control signals have no timing limitation.

When power off, VGH, VGN/VGL must start to be turned off before VDD drops to 1.6V. If the possible power off image residue is not concerned or the backlight is turned off in advance to shadow the possible image residue, there is no power off sequence limitation.

When power on: VDD → VGH, VGN/VGL  
 When power off: VGH, VGN → VGL → VDD

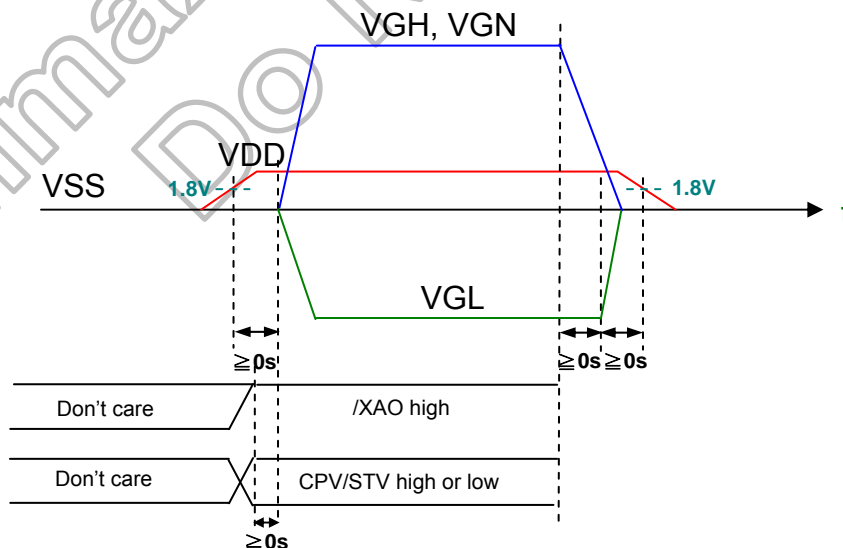

## 6. DC Characteristics

### 6.1 Absolute maximum rating (VSS=0V)

Parameter	Symbol	Spec.			Unit
		Min.	Typ.	Max.	
Power supply voltage 1	VDD	-0.3	-	+5.0	V
Power supply voltage 2	VGH	-0.3	-	VGL+42	V
Power supply voltage 3	VGL	-25	-	+0.3	V
Power supply voltage 4	VGN	VGL+3	-	VGH	V
Input voltage	V <sub>IN</sub>	-0.3	-	VDD+0.3	V
Storage temperature	T <sub>STG</sub>	-55	-	+125	°C

Note: (1) Device is subject to be damaged permanently if stresses beyond those absolute maximum ratings listed above.

### 6.2 Recommended operating conditions (VSS=0V)

Parameter	Symbol	Spec.			Unit
		Min.	Typ.	Max.	
Power supply voltage 1	VDD	1.7	3.3	5.0	V
Power supply voltage 2	VGH	7	-	VGL+40	V
Power supply voltage 3	VGL	-20	-	-5	V
Power supply voltage 4	VGH-VGL	12	-	40	V
Power supply voltage 5	VGN	VGL+4	-	VGH	V
Operation frequency	F <sub>CPV</sub>	-	-	200	KHz
Operation temperature	T <sub>A</sub>	-20	-	+85	°C

### 6.3 Electrical characteristics (VSS=0V)

Parameter	Symbol	Applicable pin	Condition	Spec.			Unit
				Min.	Typ.	Max.	
Input H voltage	V <sub>IH</sub>	All input pins	-	0.7VDD	-	VDD	V
Input L voltage	V <sub>IL</sub>	All input pins	-	VSS	-	0.3VDD	
Output H voltage	V <sub>OH</sub>	STV1,2	I <sub>OH</sub> =40μA	VDD-0.4	-	VDD	
Output L voltage	V <sub>OL</sub>	STV1,2	I <sub>OL</sub> =40μA	VSS	-	VSS+0.4	
Output H resistance	R <sub>OH</sub>	OUT1 ~ OUT480	V <sub>OUT</sub> =VGH-0.5V	-	-	1000	Ω
Output L resistance	R <sub>OL</sub>	OUT1 ~ OUT480	V <sub>OUT</sub> =VGL+0.5V	-	-	1000	Ω
Input leakage current	I <sub>IN</sub>	Note <sup>(1)</sup>	-	-5.0	-	+5.0	μA
Pull high resistance	R <sub>PU</sub>	/XAO	V <sub>IN</sub> =VSS	40	-	200	KΩ
Pull low resistance	R <sub>PD</sub>	Note <sup>(2)</sup>	VDD=3.3V	40	-	100	KΩ
Power off reset threshold voltage	V <sub>POFF</sub>	-	-	-	1.3	-	V
VDD power consumption	I <sub>VDD</sub>	-	Note <sup>(3)</sup>	-	-	100	μA
VGH power consumption	I <sub>VGH</sub>	-		-	-	100	
VGN power consumption	I <sub>VGN</sub>	VGN	Note <sup>(4)</sup>	-	-	200	

Note: (1) All input pins except /XAO, MODE1, MODE2, MODE3, SGOFF, EVEN.

(2) MODE1, MODE2, MODE3, SGOFF, EVEN.

(3) Power consumption in the following condition:

Output no load, VGH=20V, VGL=-8V, VDD=3.0V, V<sub>IH</sub>=VDD, V<sub>IL</sub>=VSS, F<sub>CPV</sub>=50KHz, OE=MODE1=MODE2=MODE3=SGOFF=EVEN=V<sub>IL</sub>, /XAO=V<sub>IH</sub>.

(4) Power consumption in the following condition:

Output no load, VGH=20V, VGL=-8V, VDD=3.0V, VGN=0V, V<sub>IH</sub>=VDD, V<sub>IL</sub>=VSS, F<sub>CPV</sub>=F<sub>OE</sub>=50KHz, OE=MODE1=MODE2=MODE3=SGOFF=EVEN=V<sub>IL</sub>, /XAO=V<sub>IH</sub>.

## 7. AC Characteristics

Parameter	Symbol	Condition	Spec.			Unit
			Min.	Typ.	Max.	
CPV period	$t_{CPV}$	-	5	-	-	μs
CPV pulse width	$t_{CPVH}, t_{CPVL}$	50% duty cycle	2.5	-	-	
OE pulse width	$t_{WOE}$	-	1	-	-	
/XAO pulse width	$t_{WXAO}$	-	10	-	-	
Data setup time	$t_{SU}$	-	0.7	-	-	
Data hold time	$t_{HD}$	-	0.7	-	-	
CPV to output delay time	$t_{PD1}$	CL=300pF	-	-	1	
Start pulse output delay time	$t_{PD2}$	Loading=30pF	-	-	0.8	
OE to output delay time	$t_{PD3}$	CL=300pF	-	-	0.8	
/XAO to output delay time	$t_{PD4}$	CL=300pF	-	-	10	

Note: (1) The measurement point for all of above signals is at 50% of input/output amplitude.

Himax Confidential  
Do Not Copy

### 8. Waveform

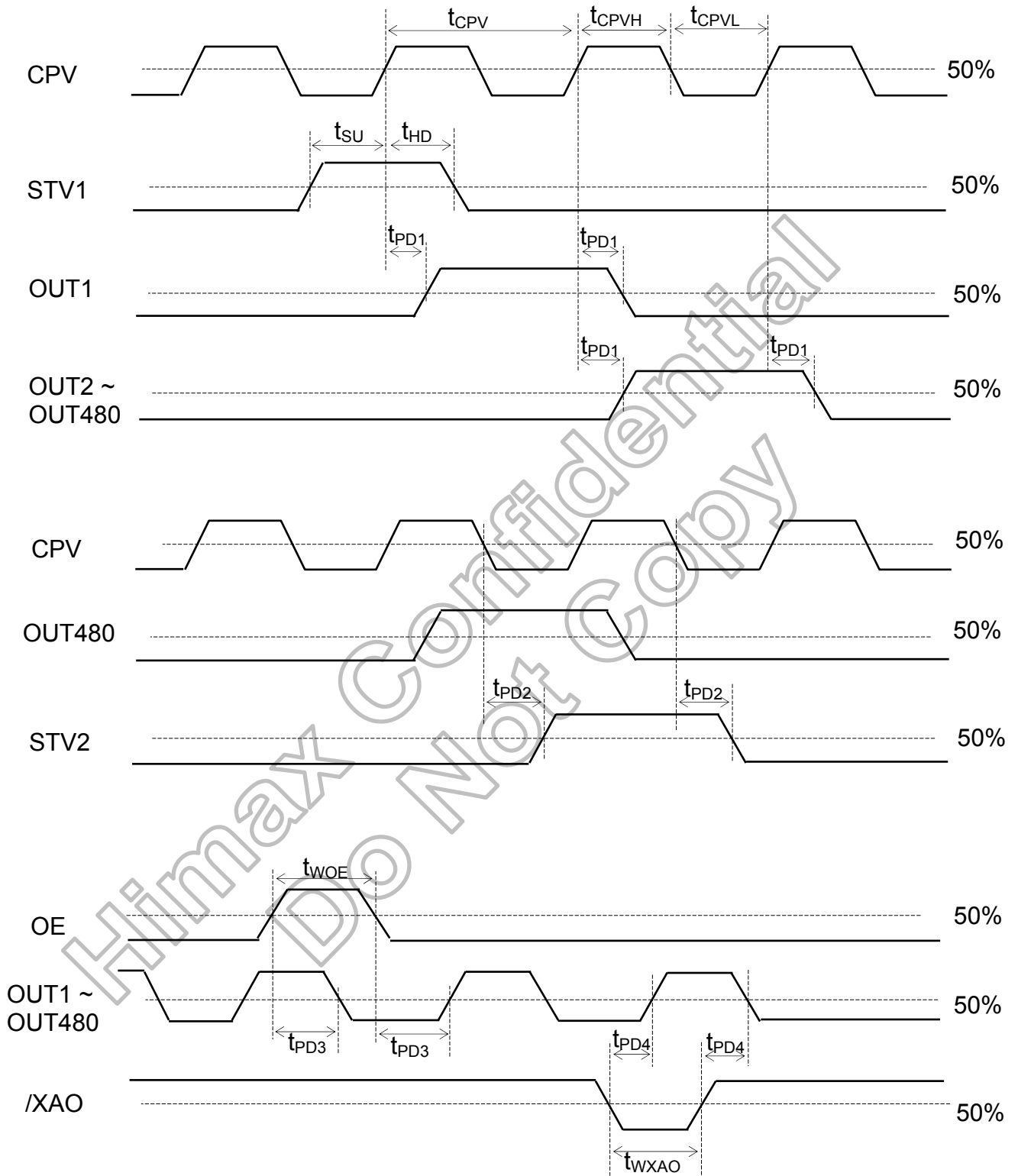

## 9. Pad Coordinates

### 9.1 HX8678-C gate driver bump location

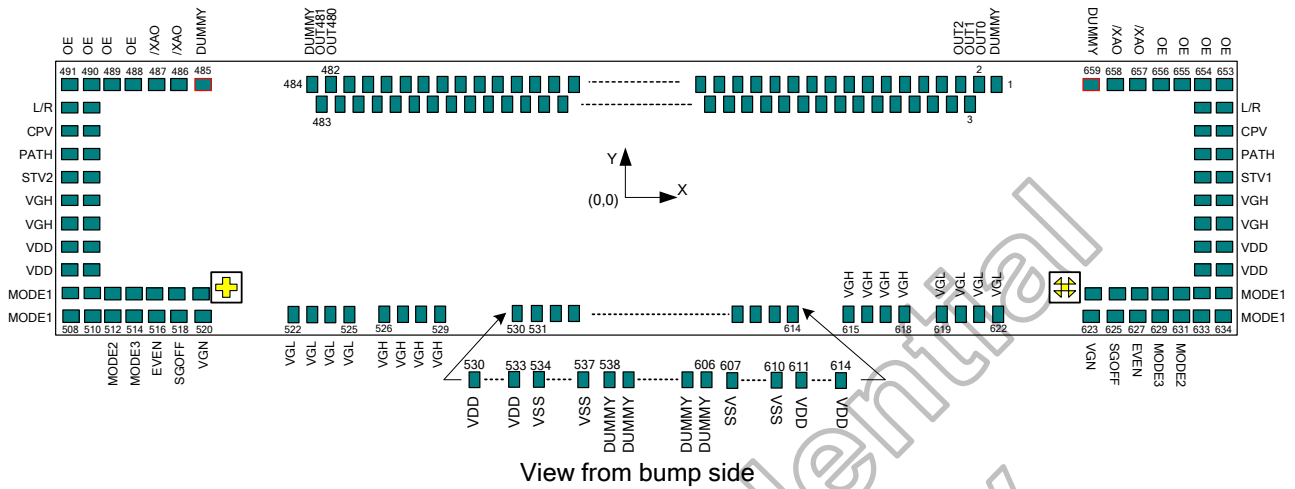

Chip size: 10880 $\mu$ m $\times$ 670 $\mu$ m (Scribe line included)

Scribe line: 80 $\mu$ m

Bump height: 12 $\pm$ 3 $\mu$ m or 9 $\pm$ 2 $\mu$ m

Total area of IC bump: 1364360 $\mu$ m<sup>2</sup>



### 9.2 Bump outline dimensions

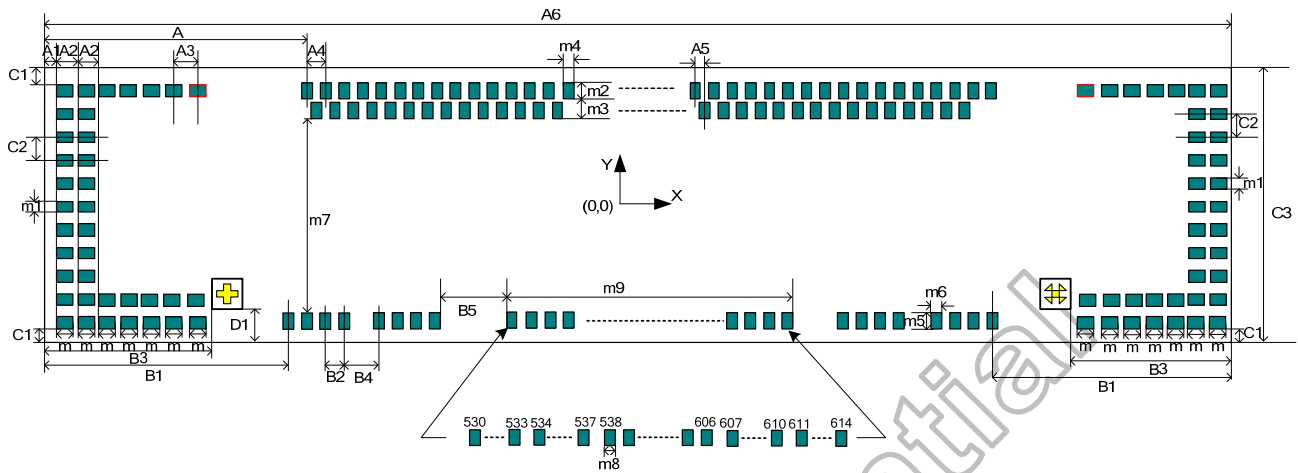

Symbol	Dimensions in $\mu\text{m}$
A	1084
A1	57
A2	90
A3	90
A4	36
A5	18
A6	10880
B1	1114
B2	52
B3	711.5
B4	72
B5	40
C1	57

Symbol	Dimensions in $\mu\text{m}$
C2	52
C3	670
D1	107.5
m	70
m1	32
m2	85
m3	110
m4	18
m5	70
m6	32
m7	291.5
m8	80
m9	7772

(Scribe line included)

### 9.3 Alignment mark

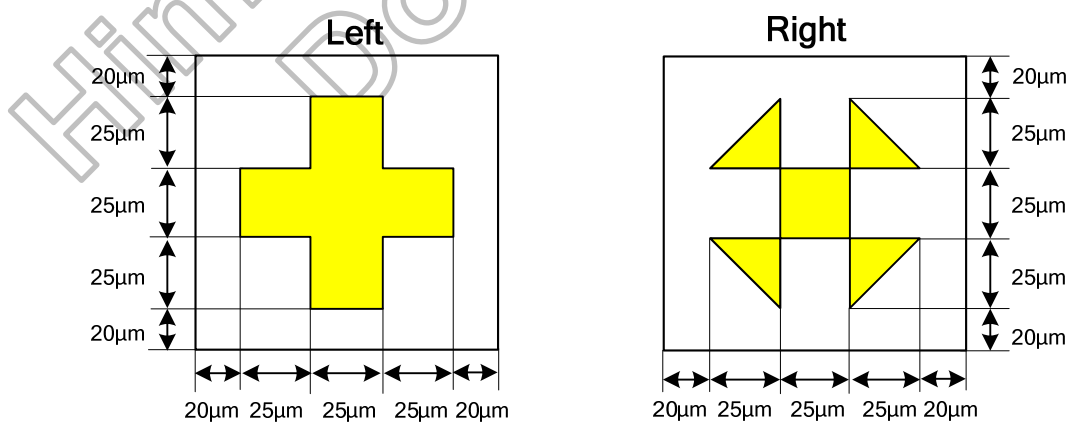

**9.4 Bump center coordinates**

No.	Name	X	Y	Bump size (µm)
1	DUMMY71	4356	236	18x85
2	OUT0	4320	236	18x85
3	OUT1	4302	126	18x85
4	OUT2	4284	236	18x85
5	OUT3	4266	126	18x85
6	OUT4	4248	236	18x85
7	OUT5	4230	126	18x85
8	OUT6	4212	236	18x85
9	OUT7	4194	126	18x85
10	OUT8	4176	236	18x85
11	OUT9	4158	126	18x85
12	OUT10	4140	236	18x85
13	OUT11	4122	126	18x85
14	OUT12	4104	236	18x85
15	OUT13	4086	126	18x85
16	OUT14	4068	236	18x85
17	OUT15	4050	126	18x85
18	OUT16	4032	236	18x85
19	OUT17	4014	126	18x85
20	OUT18	3996	236	18x85
21	OUT19	3978	126	18x85
22	OUT20	3960	236	18x85
23	OUT21	3942	126	18x85
24	OUT22	3924	236	18x85
25	OUT23	3906	126	18x85
26	OUT24	3888	236	18x85
27	OUT25	3870	126	18x85
28	OUT26	3852	236	18x85
29	OUT27	3834	126	18x85
30	OUT28	3816	236	18x85
31	OUT29	3798	126	18x85
32	OUT30	3780	236	18x85
33	OUT31	3762	126	18x85
34	OUT32	3744	236	18x85
35	OUT33	3726	126	18x85
36	OUT34	3708	236	18x85
37	OUT35	3690	126	18x85
38	OUT36	3672	236	18x85
39	OUT37	3654	126	18x85
40	OUT38	3636	236	18x85
41	OUT39	3618	126	18x85
42	OUT40	3600	236	18x85
43	OUT41	3582	126	18x85
44	OUT42	3564	236	18x85
45	OUT43	3546	126	18x85
46	OUT44	3528	236	18x85
47	OUT45	3510	126	18x85
48	OUT46	3492	236	18x85
49	OUT47	3474	126	18x85
50	OUT48	3456	236	18x85

No.	Name	X	Y	Bump size (µm)
51	OUT49	3438	126	18x85
52	OUT50	3420	236	18x85
53	OUT51	3402	126	18x85
54	OUT52	3384	236	18x85
55	OUT53	3366	126	18x85
56	OUT54	3348	236	18x85
57	OUT55	3330	126	18x85
58	OUT56	3312	236	18x85
59	OUT57	3294	126	18x85
60	OUT58	3276	236	18x85
61	OUT59	3258	126	18x85
62	OUT60	3240	236	18x85
63	OUT61	3222	126	18x85
64	OUT62	3204	236	18x85
65	OUT63	3186	126	18x85
66	OUT64	3168	236	18x85
67	OUT65	3150	126	18x85
68	OUT66	3132	236	18x85
69	OUT67	3114	126	18x85
70	OUT68	3096	236	18x85
71	OUT69	3078	126	18x85
72	OUT70	3060	236	18x85
73	OUT71	3042	126	18x85
74	OUT72	3024	236	18x85
75	OUT73	3006	126	18x85
76	OUT74	2988	236	18x85
77	OUT75	2970	126	18x85
78	OUT76	2952	236	18x85
79	OUT77	2934	126	18x85
80	OUT78	2916	236	18x85
81	OUT79	2898	126	18x85
82	OUT80	2880	236	18x85
83	OUT81	2862	126	18x85
84	OUT82	2844	236	18x85
85	OUT83	2826	126	18x85
86	OUT84	2808	236	18x85
87	OUT85	2790	126	18x85
88	OUT86	2772	236	18x85
89	OUT87	2754	126	18x85
90	OUT88	2736	236	18x85
91	OUT89	2718	126	18x85
92	OUT90	2700	236	18x85
93	OUT91	2682	126	18x85
94	OUT92	2664	236	18x85
95	OUT93	2646	126	18x85
96	OUT94	2628	236	18x85
97	OUT95	2610	126	18x85
98	OUT96	2592	236	18x85
99	OUT97	2574	126	18x85
100	OUT98	2556	236	18x85

No.	Name	X	Y	Bump size (µm)
101	OUT99	2538	126	18x85
102	OUT100	2520	236	18x85
103	OUT101	2502	126	18x85
104	OUT102	2484	236	18x85
105	OUT103	2466	126	18x85
106	OUT104	2448	236	18x85
107	OUT105	2430	126	18x85
108	OUT106	2412	236	18x85
109	OUT107	2394	126	18x85
110	OUT108	2376	236	18x85
111	OUT109	2358	126	18x85
112	OUT110	2340	236	18x85
113	OUT111	2322	126	18x85
114	OUT112	2304	236	18x85
115	OUT113	2286	126	18x85
116	OUT114	2268	236	18x85
117	OUT115	2250	126	18x85
118	OUT116	2232	236	18x85
119	OUT117	2214	126	18x85
120	OUT118	2196	236	18x85
121	OUT119	2178	126	18x85
122	OUT120	2160	236	18x85
123	OUT121	2142	126	18x85
124	OUT122	2124	236	18x85
125	OUT123	2106	126	18x85
126	OUT124	2088	236	18x85
127	OUT125	2070	126	18x85
128	OUT126	2052	236	18x85
129	OUT127	2034	126	18x85
130	OUT128	2016	236	18x85
131	OUT129	1998	126	18x85
132	OUT130	1980	236	18x85
133	OUT131	1962	126	18x85
134	OUT132	1944	236	18x85
135	OUT133	1926	126	18x85
136	OUT134	1908	236	18x85
137	OUT135	1890	126	18x85
138	OUT136	1872	236	18x85
139	OUT137	1854	126	18x85
140	OUT138	1836	236	18x85
141	OUT139	1818	126	18x85
142	OUT140	1800	236	18x85
143	OUT141	1782	126	18x85
144	OUT142	1764	236	18x85
145	OUT143	1746	126	18x85
146	OUT144	1728	236	18x85
147	OUT145	1710	126	18x85
148	OUT146	1692	236	18x85
149	OUT147	1674	126	18x85
150	OUT148	1656	236	18x85

No.	Name	X	Y	Bump size (µm)
151	OUT149	1638	126	18x85
152	OUT150	1620	236	18x85
153	OUT151	1602	126	18x85
154	OUT152	1584	236	18x85
155	OUT153	1566	126	18x85
156	OUT154	1548	236	18x85
157	OUT155	1530	126	18x85
158	OUT156	1512	236	18x85
159	OUT157	1494	126	18x85
160	OUT158	1476	236	18x85
161	OUT159	1458	126	18x85
162	OUT160	1440	236	18x85
163	OUT161	1422	126	18x85
164	OUT162	1404	236	18x85
165	OUT163	1386	126	18x85
166	OUT164	1368	236	18x85
167	OUT165	1350	126	18x85
168	OUT166	1332	236	18x85
169	OUT167	1314	126	18x85
170	OUT168	1296	236	18x85
171	OUT169	1278	126	18x85
172	OUT170	1260	236	18x85
173	OUT171	1242	126	18x85
174	OUT172	1224	236	18x85
175	OUT173	1206	126	18x85
176	OUT174	1188	236	18x85
177	OUT175	1170	126	18x85
178	OUT176	1152	236	18x85
179	OUT177	1134	126	18x85
180	OUT178	1116	236	18x85
181	OUT179	1098	126	18x85
182	OUT180	1080	236	18x85
183	OUT181	1062	126	18x85
184	OUT182	1044	236	18x85
185	OUT183	1026	126	18x85
186	OUT184	1008	236	18x85
187	OUT185	990	126	18x85
188	OUT186	972	236	18x85
189	OUT187	954	126	18x85
190	OUT188	936	236	18x85
191	OUT189	918	126	18x85
192	OUT190	900	236	18x85
193	OUT191	882	126	18x85
194	OUT192	864	236	18x85
195	OUT193	846	126	18x85
196	OUT194	828	236	18x85
197	OUT195	810	126	18x85
198	OUT196	792	236	18x85
199	OUT197	774	126	18x85
200	OUT198	756	236	18x85

No.	Name	X	Y	Bump size (µm)
201	OUT199	738	126	18x85
202	OUT200	720	236	18x85
203	OUT201	702	126	18x85
204	OUT202	684	236	18x85
205	OUT203	666	126	18x85
206	OUT204	648	236	18x85
207	OUT205	630	126	18x85
208	OUT206	612	236	18x85
209	OUT207	594	126	18x85
210	OUT208	576	236	18x85
211	OUT209	558	126	18x85
212	OUT210	540	236	18x85
213	OUT211	522	126	18x85
214	OUT212	504	236	18x85
215	OUT213	486	126	18x85
216	OUT214	468	236	18x85
217	OUT215	450	126	18x85
218	OUT216	432	236	18x85
219	OUT217	414	126	18x85
220	OUT218	396	236	18x85
221	OUT219	378	126	18x85
222	OUT220	360	236	18x85
223	OUT221	342	126	18x85
224	OUT222	324	236	18x85
225	OUT223	306	126	18x85
226	OUT224	288	236	18x85
227	OUT225	270	126	18x85
228	OUT226	252	236	18x85
229	OUT227	234	126	18x85
230	OUT228	216	236	18x85
231	OUT229	198	126	18x85
232	OUT230	180	236	18x85
233	OUT231	162	126	18x85
234	OUT232	144	236	18x85
235	OUT233	126	126	18x85
236	OUT234	108	236	18x85
237	OUT235	90	126	18x85
238	OUT236	72	236	18x85
239	OUT237	54	126	18x85
240	OUT238	36	236	18x85
241	OUT239	18	126	18x85
242	OUT240	0	236	18x85
243	OUT241	-18	126	18x85
244	OUT242	-36	236	18x85
245	OUT243	-54	126	18x85
246	OUT244	-72	236	18x85
247	OUT245	-90	126	18x85
248	OUT246	-108	236	18x85
249	OUT247	-126	126	18x85
250	OUT248	-144	236	18x85

No.	Name	X	Y	Bump size (µm)
251	OUT249	-162	126	18x85
252	OUT250	-180	236	18x85
253	OUT251	-198	126	18x85
254	OUT252	-216	236	18x85
255	OUT253	-234	126	18x85
256	OUT254	-252	236	18x85
257	OUT255	-270	126	18x85
258	OUT256	-288	236	18x85
259	OUT257	-306	126	18x85
260	OUT258	-324	236	18x85
261	OUT259	-342	126	18x85
262	OUT260	-360	236	18x85
263	OUT261	-378	126	18x85
264	OUT262	-396	236	18x85
265	OUT263	-414	126	18x85
266	OUT264	-432	236	18x85
267	OUT265	-450	126	18x85
268	OUT266	-468	236	18x85
269	OUT267	-486	126	18x85
270	OUT268	-504	236	18x85
271	OUT269	-522	126	18x85
272	OUT270	-540	236	18x85
273	OUT271	-558	126	18x85
274	OUT272	-576	236	18x85
275	OUT273	-594	126	18x85
276	OUT274	-612	236	18x85
277	OUT275	-630	126	18x85
278	OUT276	-648	236	18x85
279	OUT277	-666	126	18x85
280	OUT278	-684	236	18x85
281	OUT279	-702	126	18x85
282	OUT280	-720	236	18x85
283	OUT281	-738	126	18x85
284	OUT282	-756	236	18x85
285	OUT283	-774	126	18x85
286	OUT284	-792	236	18x85
287	OUT285	-810	126	18x85
288	OUT286	-828	236	18x85
289	OUT287	-846	126	18x85
290	OUT288	-864	236	18x85
291	OUT289	-882	126	18x85
292	OUT290	-900	236	18x85
293	OUT291	-918	126	18x85
294	OUT292	-936	236	18x85
295	OUT293	-954	126	18x85
296	OUT294	-972	236	18x85
297	OUT295	-990	126	18x85
298	OUT296	-1008	236	18x85
299	OUT297	-1026	126	18x85
300	OUT298	-1044	236	18x85

No.	Name	X	Y	Bump size (µm)	No.	Name	X	Y	Bump size (µm)
301	OUT299	-1062	126	18x85	351	OUT349	-1962	126	18x85
302	OUT300	-1080	236	18x85	352	OUT350	-1980	236	18x85
303	OUT301	-1098	126	18x85	353	OUT351	-1998	126	18x85
304	OUT302	-1116	236	18x85	354	OUT352	-2016	236	18x85
305	OUT303	-1134	126	18x85	355	OUT353	-2034	126	18x85
306	OUT304	-1152	236	18x85	356	OUT354	-2052	236	18x85
307	OUT305	-1170	126	18x85	357	OUT355	-2070	126	18x85
308	OUT306	-1188	236	18x85	358	OUT356	-2088	236	18x85
309	OUT307	-1206	126	18x85	359	OUT357	-2106	126	18x85
310	OUT308	-1224	236	18x85	360	OUT358	-2124	236	18x85
311	OUT309	-1242	126	18x85	361	OUT359	-2142	126	18x85
312	OUT310	-1260	236	18x85	362	OUT360	-2160	236	18x85
313	OUT311	-1278	126	18x85	363	OUT361	-2178	126	18x85
314	OUT312	-1296	236	18x85	364	OUT362	-2196	236	18x85
315	OUT313	-1314	126	18x85	365	OUT363	-2214	126	18x85
316	OUT314	-1332	236	18x85	366	OUT364	-2232	236	18x85
317	OUT315	-1350	126	18x85	367	OUT365	-2250	126	18x85
318	OUT316	-1368	236	18x85	368	OUT366	-2268	236	18x85
319	OUT317	-1386	126	18x85	369	OUT367	-2286	126	18x85
320	OUT318	-1404	236	18x85	370	OUT368	-2304	236	18x85
321	OUT319	-1422	126	18x85	371	OUT369	-2322	126	18x85
322	OUT320	-1440	236	18x85	372	OUT370	-2340	236	18x85
323	OUT321	-1458	126	18x85	373	OUT371	-2358	126	18x85
324	OUT322	-1476	236	18x85	374	OUT372	-2376	236	18x85
325	OUT323	-1494	126	18x85	375	OUT373	-2394	126	18x85
326	OUT324	-1512	236	18x85	376	OUT374	-2412	236	18x85
327	OUT325	-1530	126	18x85	377	OUT375	-2430	126	18x85
328	OUT326	-1548	236	18x85	378	OUT376	-2448	236	18x85
329	OUT327	-1566	126	18x85	379	OUT377	-2466	126	18x85
330	OUT328	-1584	236	18x85	380	OUT378	-2484	236	18x85
331	OUT329	-1602	126	18x85	381	OUT379	-2502	126	18x85
332	OUT330	-1620	236	18x85	382	OUT380	-2520	236	18x85
333	OUT331	-1638	126	18x85	383	OUT381	-2538	126	18x85
334	OUT332	-1656	236	18x85	384	OUT382	-2556	236	18x85
335	OUT333	-1674	126	18x85	385	OUT383	-2574	126	18x85
336	OUT334	-1692	236	18x85	386	OUT384	-2592	236	18x85
337	OUT335	-1710	126	18x85	387	OUT385	-2610	126	18x85
338	OUT336	-1728	236	18x85	388	OUT386	-2628	236	18x85
339	OUT337	-1746	126	18x85	389	OUT387	-2646	126	18x85
340	OUT338	-1764	236	18x85	390	OUT388	-2664	236	18x85
341	OUT339	-1782	126	18x85	391	OUT389	-2682	126	18x85
342	OUT340	-1800	236	18x85	392	OUT390	-2700	236	18x85
343	OUT341	-1818	126	18x85	393	OUT391	-2718	126	18x85
344	OUT342	-1836	236	18x85	394	OUT392	-2736	236	18x85
345	OUT343	-1854	126	18x85	395	OUT393	-2754	126	18x85
346	OUT344	-1872	236	18x85	396	OUT394	-2772	236	18x85
347	OUT345	-1890	126	18x85	397	OUT395	-2790	126	18x85
348	OUT346	-1908	236	18x85	398	OUT396	-2808	236	18x85
349	OUT347	-1926	126	18x85	399	OUT397	-2826	126	18x85
350	OUT348	-1944	236	18x85	400	OUT398	-2844	236	18x85

No.	Name	X	Y	Bump size (µm)	No.	Name	X	Y	Bump size (µm)
401	OUT399	-2862	126	18x85	451	OUT449	-3762	126	18x85
402	OUT400	-2880	236	18x85	452	OUT450	-3780	236	18x85
403	OUT401	-2898	126	18x85	453	OUT451	-3798	126	18x85
404	OUT402	-2916	236	18x85	454	OUT452	-3816	236	18x85
405	OUT403	-2934	126	18x85	455	OUT453	-3834	126	18x85
406	OUT404	-2952	236	18x85	456	OUT454	-3852	236	18x85
407	OUT405	-2970	126	18x85	457	OUT455	-3870	126	18x85
408	OUT406	-2988	236	18x85	458	OUT456	-3888	236	18x85
409	OUT407	-3006	126	18x85	459	OUT457	-3906	126	18x85
410	OUT408	-3024	236	18x85	460	OUT458	-3924	236	18x85
411	OUT409	-3042	126	18x85	461	OUT459	-3942	126	18x85
412	OUT410	-3060	236	18x85	462	OUT460	-3960	236	18x85
413	OUT411	-3078	126	18x85	463	OUT461	-3978	126	18x85
414	OUT412	-3096	236	18x85	464	OUT462	-3996	236	18x85
415	OUT413	-3114	126	18x85	465	OUT463	-4014	126	18x85
416	OUT414	-3132	236	18x85	466	OUT464	-4032	236	18x85
417	OUT415	-3150	126	18x85	467	OUT465	-4050	126	18x85
418	OUT416	-3168	236	18x85	468	OUT466	-4068	236	18x85
419	OUT417	-3186	126	18x85	469	OUT467	-4086	126	18x85
420	OUT418	-3204	236	18x85	470	OUT468	-4104	236	18x85
421	OUT419	-3222	126	18x85	471	OUT469	-4122	126	18x85
422	OUT420	-3240	236	18x85	472	OUT470	-4140	236	18x85
423	OUT421	-3258	126	18x85	473	OUT471	-4158	126	18x85
424	OUT422	-3276	236	18x85	474	OUT472	-4176	236	18x85
425	OUT423	-3294	126	18x85	475	OUT473	-4194	126	18x85
426	OUT424	-3312	236	18x85	476	OUT474	-4212	236	18x85
427	OUT425	-3330	126	18x85	477	OUT475	-4230	126	18x85
428	OUT426	-3348	236	18x85	478	OUT476	-4248	236	18x85
429	OUT427	-3366	126	18x85	479	OUT477	-4266	126	18x85
430	OUT428	-3384	236	18x85	480	OUT478	-4284	236	18x85
431	OUT429	-3402	126	18x85	481	OUT479	-4302	126	18x85
432	OUT430	-3420	236	18x85	482	OUT480	-4320	236	18x85
433	OUT431	-3438	126	18x85	483	OUT481	-4338	126	18x85
434	OUT432	-3456	236	18x85	484	DUMMY72	-4356	236	18x85
435	OUT433	-3474	126	18x85	485	DUMMY73	-4808	262	70x32
436	OUT434	-3492	236	18x85	486	/XAO	-4898	262	70x32
437	OUT435	-3510	126	18x85	487	/XAO	-4988	262	70x32
438	OUT436	-3528	236	18x85	488	OE	-5078	262	70x32
439	OUT437	-3546	126	18x85	489	OE	-5168	262	70x32
440	OUT438	-3564	236	18x85	490	OE	-5258	262	70x32
441	OUT439	-3582	126	18x85	491	OE	-5348	262	70x32
442	OUT440	-3600	236	18x85	492	L/R	-5258	208	70x32
443	OUT441	-3618	126	18x85	493	L/R	-5348	208	70x32
444	OUT442	-3636	236	18x85	494	CPV	-5258	156	70x32
445	OUT443	-3654	126	18x85	495	CPV	-5348	156	70x32
446	OUT444	-3672	236	18x85	496	PATH	-5258	104	70x32
447	OUT445	-3690	126	18x85	497	PATH	-5348	104	70x32
448	OUT446	-3708	236	18x85	498	STV2	-5258	52	70x32
449	OUT447	-3726	126	18x85	499	STV2	-5348	52	70x32
450	OUT448	-3744	236	18x85	500	VGH	-5258	0	70x32

No.	Name	X	Y	Bump size (µm)	No.	Name	X	Y	Bump size (µm)
501	VGH	-5348	0	70x32	551	DUMMY14	-2100	-243	80x70
502	VGH	-5258	-52	70x32	552	DUMMY15	-2000	-243	80x70
503	VGH	-5348	-52	70x32	553	DUMMY16	-1900	-243	80x70
504	VDD	-5258	-104	70x32	554	DUMMY17	-1800	-243	80x70
505	VDD	-5348	-104	70x32	555	DUMMY18	-1700	-243	80x70
506	VDD	-5258	-156	70x32	556	DUMMY19	-1600	-243	80x70
507	VDD	-5348	-156	70x32	557	DUMMY20	-1500	-243	80x70
508	MODE1	-5258	-208	70x32	558	DUMMY21	-1400	-243	80x70
509	MODE1	-5348	-208	70x32	559	DUMMY22	-1300	-243	80x70
510	MODE1	-5258	-262	70x32	560	DUMMY23	-1200	-243	80x70
511	MODE1	-5348	-262	70x32	561	DUMMY24	-1100	-243	80x70
512	MODE2	-5168	-262	70x32	562	DUMMY25	-1000	-243	80x70
513	MODE2	-5168	-208	70x32	563	DUMMY26	-900	-243	80x70
514	MODE3	-5078	-262	70x32	564	DUMMY27	-800	-243	80x70
515	MODE3	-5078	-208	70x32	565	DUMMY28	-700	-243	80x70
516	EVEN	-4988	-262	70x32	566	DUMMY29	-600	-243	80x70
517	EVEN	-4988	-208	70x32	567	DUMMY30	-500	-243	80x70
518	SGOFF	-4898	-262	70x32	568	DUMMY31	-400	-243	80x70
519	SGOFF	-4898	-208	70x32	569	DUMMY32	-300	-243	80x70
520	VGN	-4808	-262	70x32	570	DUMMY33	-200	-243	80x70
521	VGN	-4808	-208	70x32	571	DUMMY34	-100	-243	80x70
522	VGL	-4326	-243	32x70	572	DUMMY35	0	-243	80x70
523	VGL	-4274	-243	32x70	573	DUMMY36	100	-243	80x70
524	VGL	-4222	-243	32x70	574	DUMMY37	200	-243	80x70
525	VGL	-4170	-243	32x70	575	DUMMY38	300	-243	80x70
526	VGH	-4098	-243	32x70	576	DUMMY39	400	-243	80x70
527	VGH	-4046	-243	32x70	577	DUMMY40	500	-243	80x70
528	VGH	-3994	-243	32x70	578	DUMMY41	600	-243	80x70
529	VGH	-3942	-243	32x70	579	DUMMY42	700	-243	80x70
530	VDD	-3870	-243	32x70	580	DUMMY43	800	-243	80x70
531	VDD	-3818	-243	32x70	581	DUMMY44	900	-243	80x70
532	VDD	-3766	-243	32x70	582	DUMMY45	1000	-243	80x70
533	VDD	-3714	-243	32x70	583	DUMMY46	1100	-243	80x70
534	VSS	-3642	-243	32x70	584	DUMMY47	1200	-243	80x70
535	VSS	-3590	-243	32x70	585	DUMMY48	1300	-243	80x70
536	VSS	-3538	-243	32x70	586	DUMMY49	1400	-243	80x70
537	VSS	-3486	-243	32x70	587	DUMMY50	1500	-243	80x70
538	DUMMY1	-3400	-243	80x70	588	DUMMY51	1600	-243	80x70
539	DUMMY2	-3300	-243	80x70	589	DUMMY52	1700	-243	80x70
540	DUMMY3	-3200	-243	80x70	590	DUMMY53	1800	-243	80x70
541	DUMMY4	-3100	-243	80x70	591	DUMMY54	1900	-243	80x70
542	DUMMY5	-3000	-243	80x70	592	DUMMY55	2000	-243	80x70
543	DUMMY6	-2900	-243	80x70	593	DUMMY56	2100	-243	80x70
544	DUMMY7	-2800	-243	80x70	594	DUMMY57	2200	-243	80x70
545	DUMMY8	-2700	-243	80x70	595	DUMMY58	2300	-243	80x70
546	DUMMY9	-2600	-243	80x70	596	DUMMY59	2400	-243	80x70
547	DUMMY10	-2500	-243	80x70	597	DUMMY60	2500	-243	80x70
548	DUMMY11	-2400	-243	80x70	598	DUMMY61	2600	-243	80x70
549	DUMMY12	-2300	-243	80x70	599	DUMMY62	2700	-243	80x70
550	DUMMY13	-2200	-243	80x70	600	DUMMY63	2800	-243	80x70

No.	Name	X	Y	Bump size (µm)
601	DUMMY64	2900	-243	80x70
602	DUMMY65	3000	-243	80x70
603	DUMMY66	3100	-243	80x70
604	DUMMY67	3200	-243	80x70
605	DUMMY68	3300	-243	80x70
606	DUMMY69	3400	-243	80x70
607	VSS	3486	-243	32x70
608	VSS	3538	-243	32x70
609	VSS	3590	-243	32x70
610	VSS	3642	-243	32x70
611	VDD	3714	-243	32x70
612	VDD	3766	-243	32x70
613	VDD	3818	-243	32x70
614	VDD	3870	-243	32x70
615	VGH	3942	-243	32x70
616	VGH	3994	-243	32x70
617	VGH	4046	-243	32x70
618	VGH	4098	-243	32x70
619	VGL	4170	-243	32x70
620	VGL	4222	-243	32x70
621	VGL	4274	-243	32x70
622	VGL	4326	-243	32x70
623	VGN	4808	-262	70x32
624	VGN	4808	-208	70x32
625	SGOFF	4898	-262	70x32
626	SGOFF	4898	-208	70x32
627	EVEN	4988	-262	70x32
628	EVEN	4988	-208	70x32
629	MODE3	5078	-262	70x32
630	MODE3	5078	-208	70x32

No.	Name	X	Y	Bump size (µm)
631	MODE2	5168	-262	70x32
632	MODE2	5168	-208	70x32
633	MODE1	5258	-262	70x32
634	MODE1	5348	-262	70x32
635	MODE1	5258	-208	70x32
636	MODE1	5348	-208	70x32
637	VDD	5258	-156	70x32
638	VDD	5348	-156	70x32
639	VDD	5258	-104	70x32
640	VDD	5348	-104	70x32
641	VGH	5258	-52	70x32
642	VGH	5348	-52	70x32
643	VGH	5258	0	70x32
644	VGH	5348	0	70x32
645	STV1	5258	52	70x32
646	STV1	5348	52	70x32
647	PATH	5258	104	70x32
648	PATH	5348	104	70x32
649	CPV	5258	156	70x32
650	CPV	5348	156	70x32
651	L/R	5258	208	70x32
652	L/R	5348	208	70x32
653	OE	5258	262	70x32
654	OE	5348	262	70x32
655	OE	5168	262	70x32
656	OE	5078	262	70x32
657	/XAO	4988	262	70x32
658	/XAO	4898	262	70x32
659	DUMMY70	4808	262	70x32

### 9.5 Alignment mark center coordinates

Name	X	Y
L_AMK	-4671	-170
R_AMK	4671	-170



## 10. Ordering Information

Part no.	Package
HX8678-C00XPDxxx	X: mean fab code PD: mean COG xxx: mean chip thickness ( $\mu\text{m}$ ), default 400 $\mu\text{m}$

Himax Confidential  
Do Not Copy