

E35RG63224LW2M350-N 16BIT RGB

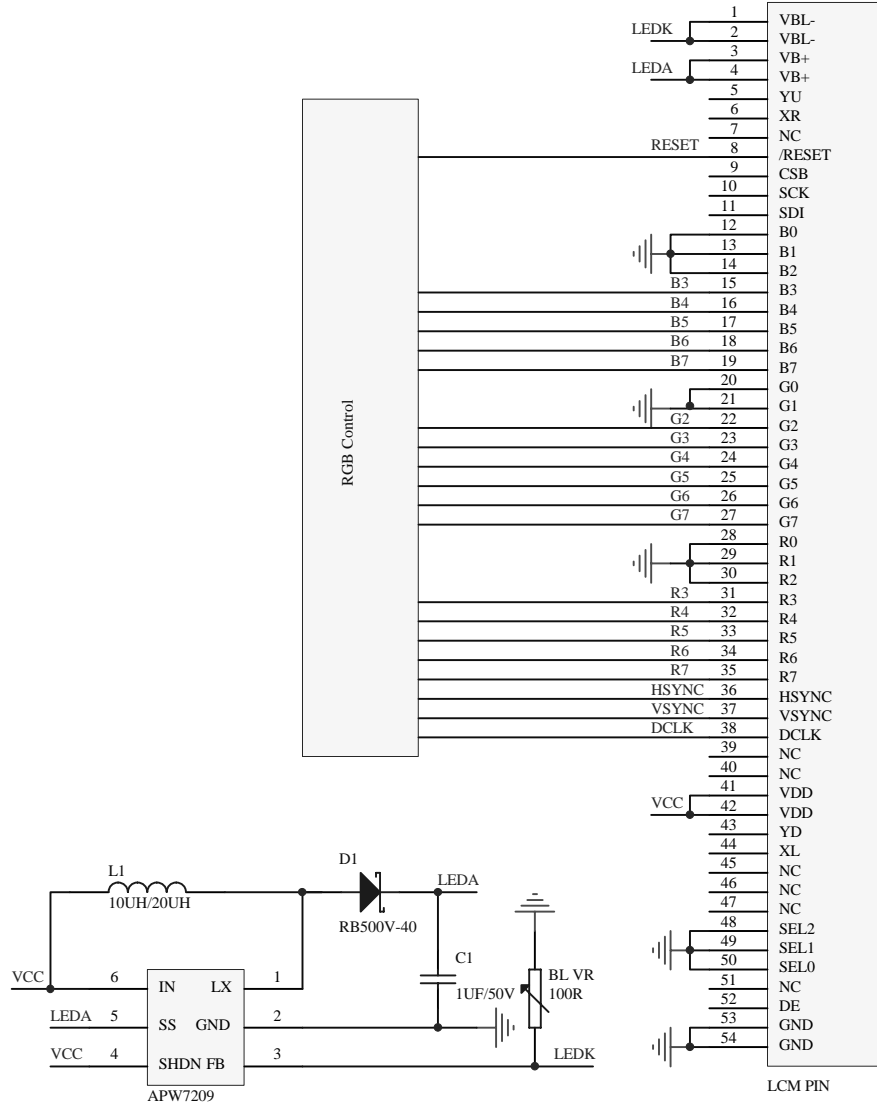

NOTE: 1.Interface: 16BIT RGB
2.VCC=3.3V

