

E35RG83224LW2M250-C 24BIT RGB Interface

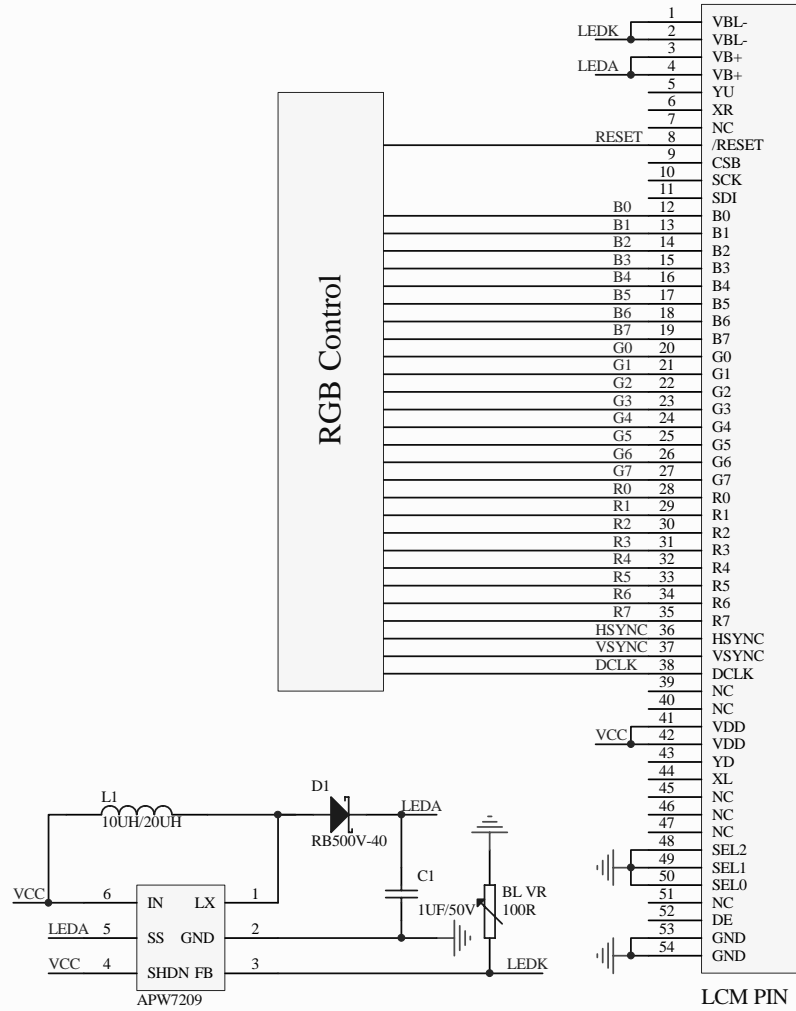

NOTE: 1.Interface: 24BIT RGB

2.VCC=3.3V

PROPRIETARY AND CONFIDENTIAL
 THE INFORMATION CONTAINED IN THIS DRAWING IS THE SOLE PROPERTY OF FOCUS DISPLAY SOLUTIONS, INC. ANY REPRODUCTION IN PART OR AS A WHOLE WITHOUT THE WRITTEN PERMISSIONS OF FOCUS DISPLAY SOLUTIONS, INC. IS PROHIBITED

Model Name: E35RG83224LW2M250-C

General Tol: ± 0.2

Approvals: _____ Date: _____

DWN: _____

CHK: _____

APP: _____



Drawing No.: _____ Scale: _____

Size: _____ Unit: mm Page: 1/1

