

E50RD-I-MW420-C 2 Lane MIPI Interface

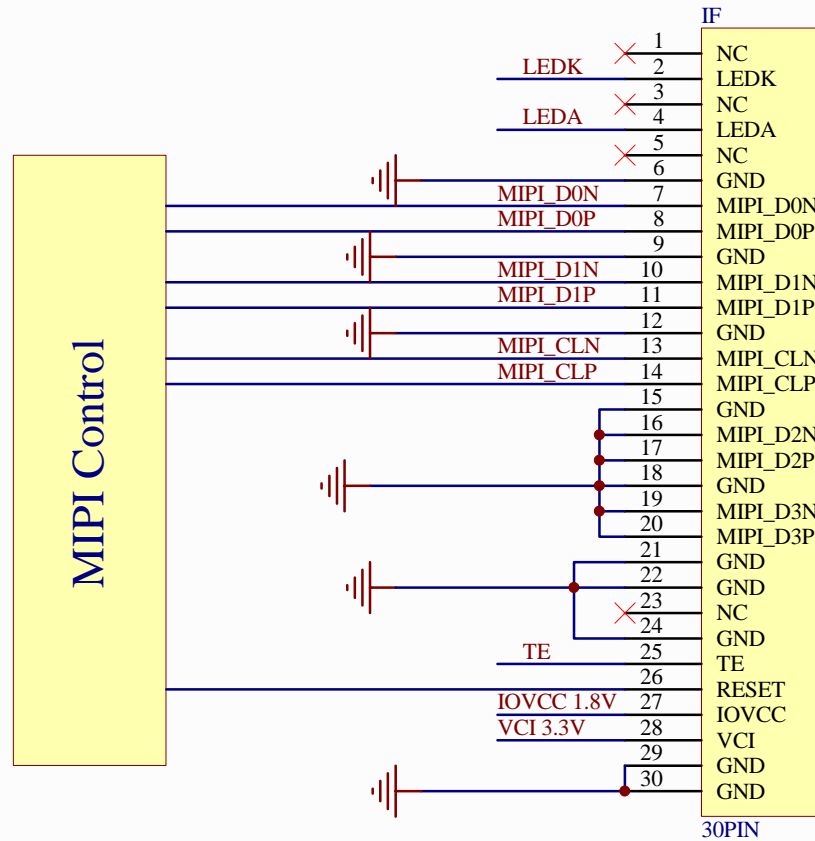

PROPRIETARY AND CONFIDENTIAL
 THE INFORMATION CONTAINED IN THIS DRAWING IS THE SOLE PROPERTY OF FOCUS DISPLAY SOLUTIONS, INC. ANY REPRODUCTION IN PART OR AS A WHOLE WITHOUT THE WRITTEN PERMISSIONS OF FOCUS DISPLAY SOLUTIONS, INC. IS PROHIBITED

Model Name: E50RD-I-MW420-C	
General Tol:	± 0.2
Approvals	Date
DWN:	
CHK:	
APP:	

FOCUS LCDs
LCDs MADE SIMPLE®

Drawing No.:		Scale:	
Size:		Unit: mm	Page: 1/1