



FocusLCDs.com

LCDs MADE SIMPLE®

Ph. 480-503-4295 | NOPP@FocusLCD.com

TFT | CHARACTER | UWVD | FSC | SEGMENT | CUSTOM | REPLACEMENT

Character Display Module

Part Number

C402ASBSYLY6WT55PAB

Overview

40x2(182x33.5), STN, Yellow/Green background, Yellow/Green LED, Bottom view, Wide temp, Transflective (positive), 5V LCD, 5V LED, Controller=SPLC780D, RoHS Compliant

1. Mechanical Specification

ITEM	STANDARD VALUE	UNIT			
NUMBER OF CHARACTERS	40 CHARACTERS X 2 LINES	--			
CHARACTER FORMAT	5 X 8 DOTS	--			
MODULE DIMENSION NO BACKLIGHT	182.0 (W) X 33.5 (H) X 10.5 (T)	mm			
MODULE DIMENSION ARRAY LED BACKLIGHT	182.0 (W) X 33.5 (H) X 15.0 (T)	mm			
VIEWING DISPLAY AREA	153.6 (W) X 16.2 (H)	mm			
ACTIVE DISPLAY AREA	147.5 (W) X 11.5 (H)	mm			
CHARACTER SIZE	3.20 (W) X 5.55 (H)	mm			
CHARACTER PITCH	3.70 (W) X 5.95 (H)	mm			
DOT SIZE	0.60 (W) X 0.65 (H)	mm			
DOT PITCH	0.65 (W) X 0.70 (H)	mm			
● ARRAY LED BACKLIGHT COLOR	YELLOW GREEN OR ORANGE OR RED				
BACKLIGHT INPUT	DC +4.0V	V			
BACKLIGHT HALF-LIFT TIME	250 (Type)	mA			
	30,000 (Ta=25°C)	HR.			
LED Backlight Characteristics (without LCD) Ta=25°C					
Item	Min.	Type	Max.	Unit	Condition
Forward Voltage				V	If= mA
Reverse Current	--	--		μA	If= mA
Peak Wave Length	--	--	--	nm	If= mA
Chromaticity Coordinates	X=		Y=		If= mA
Luminance		--	--	cd/m ²	If= mA

2. Mechanical Diagram

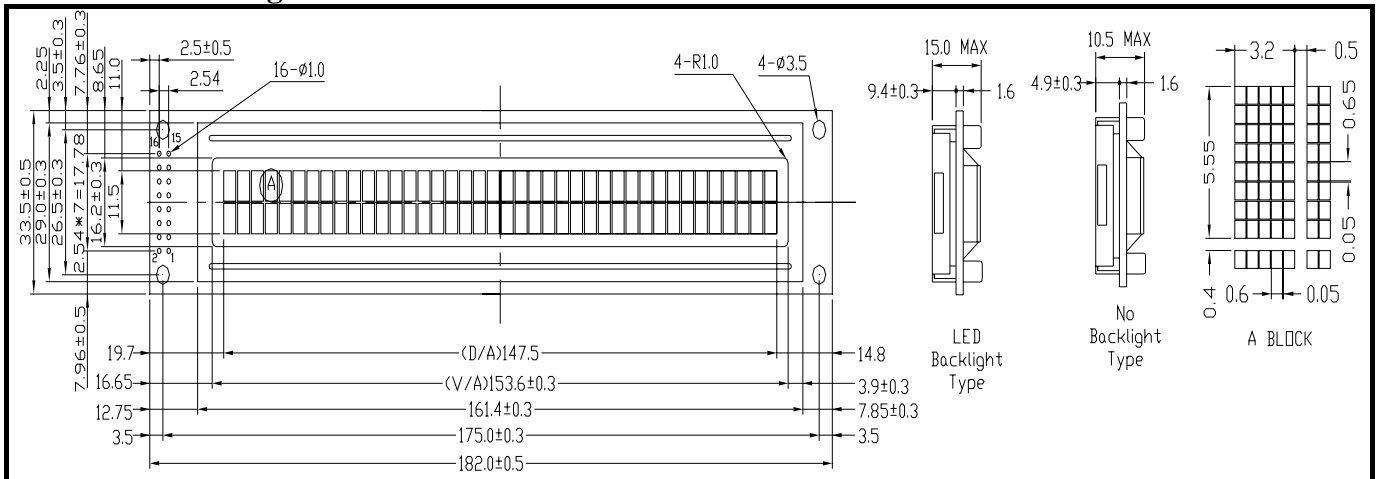

3. Interface Pin Connections

NO	SYMBOL	LEVEL	FUNCTION
1	VSS	--	GND (0V)
2	VDD	--	DC +5V
3	VO	--	Contrast Adjust
4	RS	H/L	Register select
5	R/W	H/L	Read/Write
6	E	H,H→L	Enable signal
7	DB0	H/L	Data Bit 0
8	DB1	H/L	Data Bit 1
9	DB2	H/L	Data Bit 2
10	DB3	H/L	Data Bit 3
11	DB4	H/L	Data Bit 4
12	DB5	H/L	Data Bit 5
13	DB6	H/L	Data Bit 6
14	DB7	H/L	Data Bit 7
15	A(+)	DC+5.0V	LED Backlight +
16	K(-)	0V	LED Backlight -

4. Block Diagram

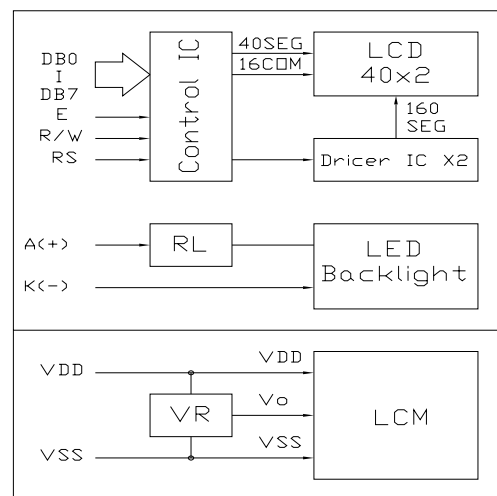

5. Absolute Maximum Ratings

ITEM		SYMBOL	MIN.	TYPE	MAX.	UNIT
INPUT VOLTAGE		VI	VSS	—	VDD	V
SUPPLY VOLTAGE FOR LOGIC		VDD-VSS	—	5.0	6.5	V
SUPPLY VOLTAGE FOR LCD		VDD-VO	—	—	6.5	V
TN	NORMAL TEMPERATURE RANGE	OPERATING	0~+50	STORAGE	-10~+60	°C
HTN	WIDE TEMPERATURE RANGE	OPERATING	-20~+70	STORAGE	-30~+80	°C
STN	WIDE TEMPERATURE RANGE	OPERATING	-20~+70	STORAGE	-30~+80	°C
FSTN						
STATIC ELECTRICITY		Be sure that you are grounded when handing LCM.				

6. Electrical Characteristics

ITEM		SYN	CONDITION	MIN.	TYPE	MAX.	UNIT
SUPPLY VOLTAGE FOR LOGIC		VDD – VSS	—	4.5	5.0	5.5	V
SUPPLY VOLTAGE FOR LCD		VDD – VO	Ta=0/-20°C	—	4.6/4.8	—	V
			Ta=+25°C	4.1	4.3	4.5	V
			Ta=+50/+70°C	—	4.0/3.9	—	V
INPUT HIGH VOLTAGE		VIH	—	2.5	—	VDD	V
INPUT LOW VOLTAGE		VIL	—	0	—	0.6	V
OUTPUT HIGH VOLTAGE		VOH	—	2.4	—	—	V
OUTPUT LOW VOLTAGE		VOL	—	—	—	0.4	V
SUPPLY CURRENT		IDD	VDD=+5V	—	4.0	5.5	mA

7. Optical Characteristics

Ta at 25°C

ITEM	SYM	CONDITION	MIN.	TYPE	MAX.	UNIT
VIEW ANGLE (TOP/BOTTOM)	$\theta 2 / \theta 1$	CR ≥ 2	—	15° / 35° (35° / 45°)	—	deg.
VIEW ANGLE (LEFT/RIGHT)	$\phi 1 / \phi 2$	CR ≥ 2	—	35° / 35°	—	deg.
CONTRAST RATIO	CR	—	—	4.5	—	—
RESPONSE TIME (RISE)	TON/Tr	—	—	170	—	mS
RESPONSE TIME (DECAY)	TOFF/Tf	—	—	220	—	mS

8. Optical Definitions

Response Time

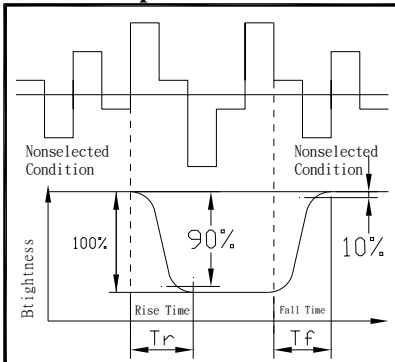

Contrast Ratio

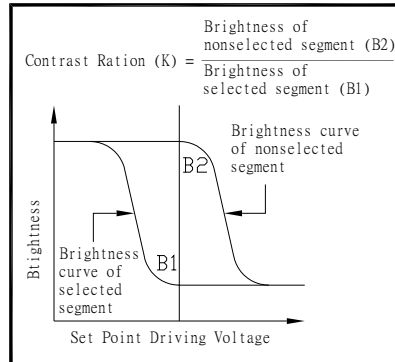

View Angle

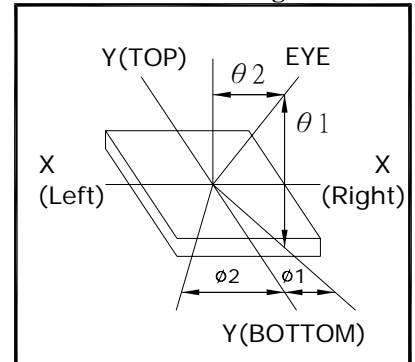

9. Display Address

	1	2	3	4	5	6	7	8	9	10	11	12	13	14	15	16	17	18	19	20
Line 1	80	81	82	83	84	85	86	87	88	89	8A	8B	8C	8D	8E	8F	90	91	92	93
Line 2	C0	C1	C2	C3	C4	C5	C6	C7	C8	C9	CA	CB	CC	CD	CE	CF	D0	D1	D2	D3
Line 3																				
Line 4																				

	21	22	23	24	25	26	27	28	29	30	31	32	33	34	35	36	37	38	39	40
Line 1	94	95	96	97	98	99	9A	9B	9C	9D	9E	9F	A0	A1	A2	A3	A4	A5	A6	A7
Line 2	D4	D5	D6	D7	D8	D9	DA	DB	DC	DD	DE	DF	E0	E1	E2	E3	E4	E5	E6	E7
Line 3																				
Line 4																				

10. Interface to MPU

10.1 Interface to Z-80 CPU

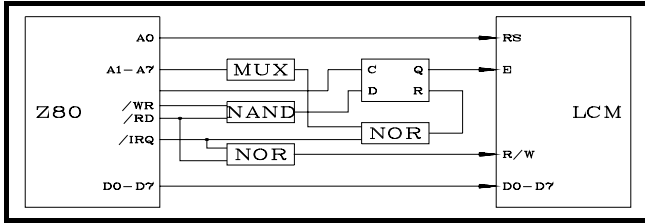

10.3 Interface to 4-bit CPU (HMCS43C)

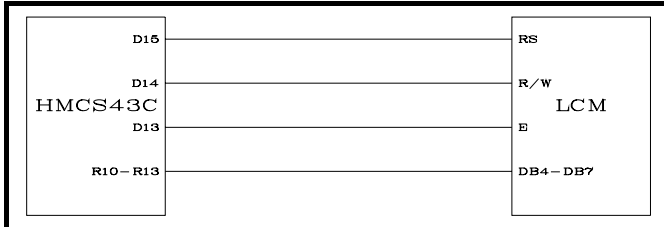

10.2 Interface to MC6800 CPU

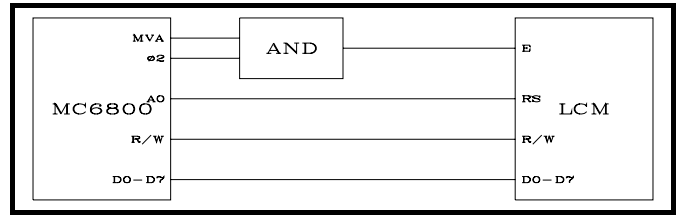

10.4 Interface to HD6805 MP

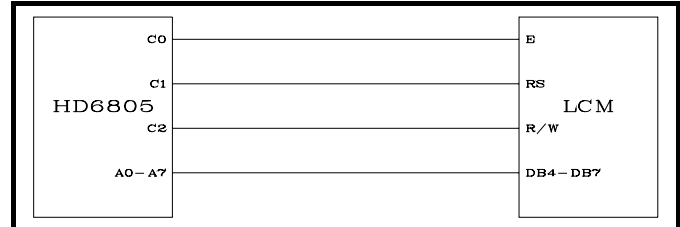

11. Timing Control

11.1 Write and Read Operation

Write Operation

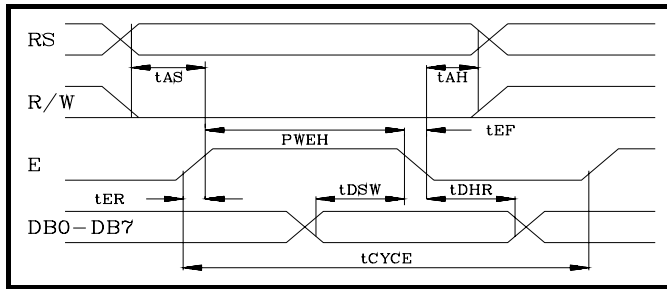

Read Operation

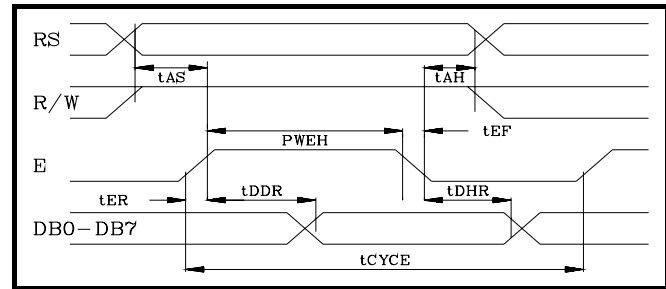

Item	Symbol	Limit (Min.)	Limit (Max.)	Unit
Enable Cycle Time	tCYCE	400	--	ns
Enable Pules Width (High level)	PWEH	150	--	ns
Enable Rise/Fall Time	tER,tEF	--	25	ns
Address Set-Up Time (RS,R/W,E)	tAS	30	--	ns
Address Hole Time	tAH	10	--	ns
Data Set-Up Time	tDSW	40	--	ns
Data Delay Time	tDDR	--	100	ns
Data Hold Time	tDHR	20	--	ns

11.2 Busy flag check timing

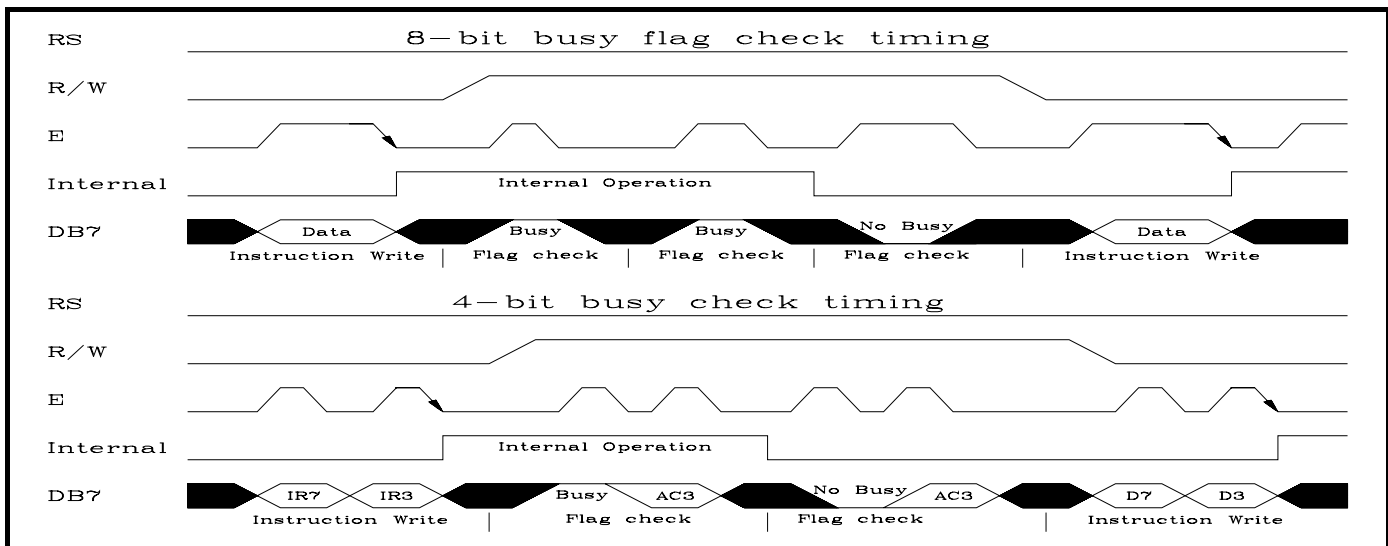

Note: IR7, IR3: Instruction 7th bit, 3rd bit; AC3: Address Counter 3rd bit.

12. Initialization of LCM

The LCM automatically initializes (reset) when power is turned on using the internal reset circuit. If the power supply conditions for correctly operating of the internal reset circuit are not met, initialization by instruction is required. Use the procedure is next page for initialization.

Internal Power Supply reset

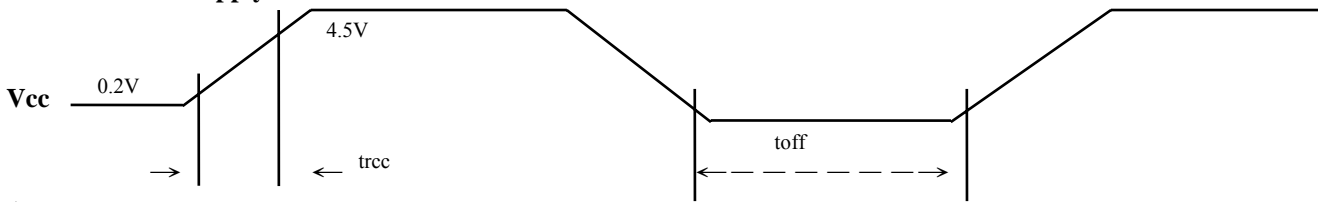

(Note 1) $10\text{ ms} \geq trcc \geq 0.1\text{ ms}$, $toff \geq 1\text{ ms}$.

(Note 2) $toff$ stipulates the time of power OFF for momentary power supply dip or when power supply cycles ON and OFF.

Item	Symbol	Test condition	Limit (Min.)	Limit (Max.)	Unit
Power supply rise time	$trcc$	--	0.1	10	ms
Power supply off time	$toff$	--	1	--	ms

(a) 8-bit interface

(b) 4-bit interface

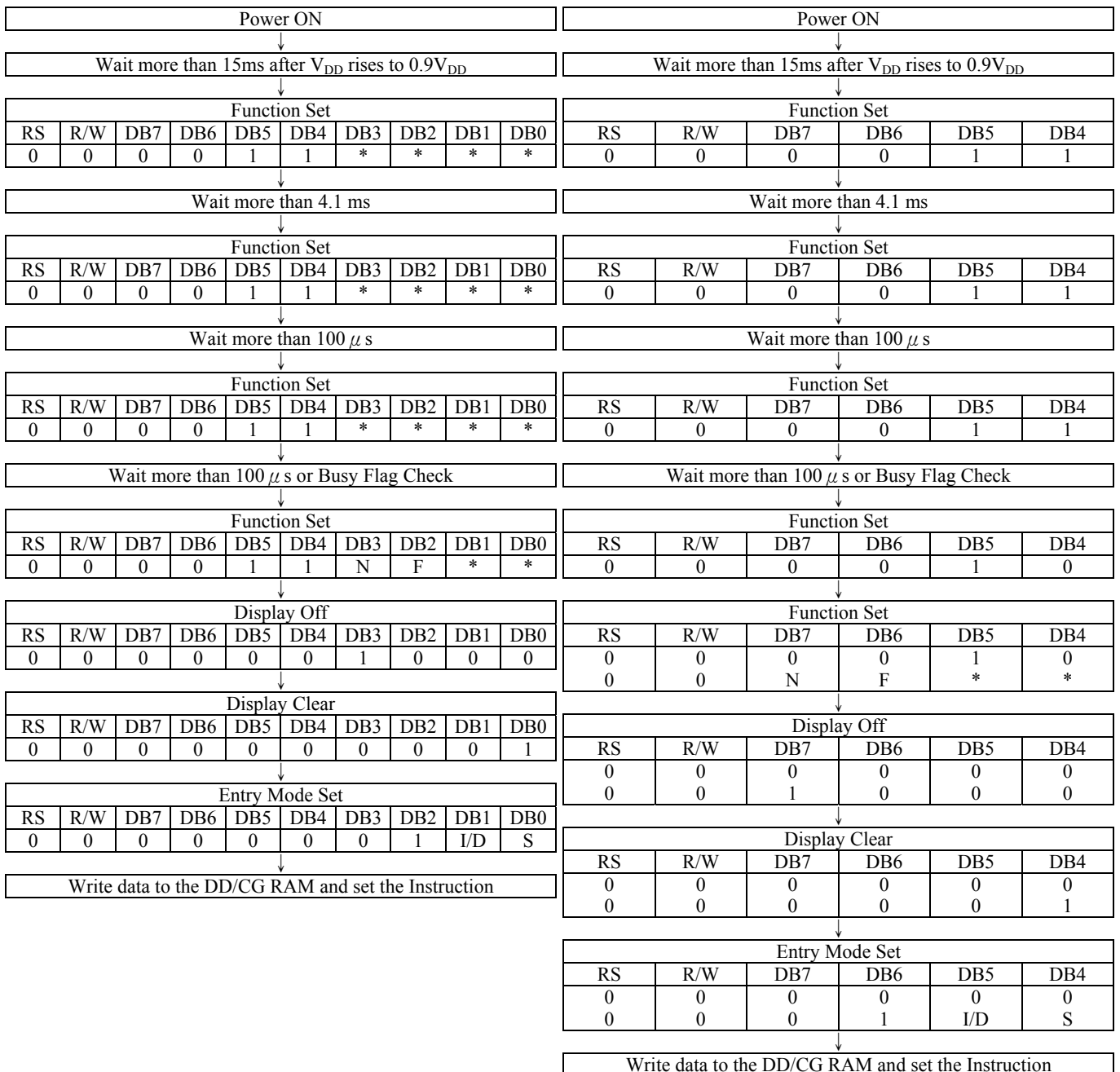

13. Instruction Set

FUNCTION	R S	R /W	D B 7	D B 6	D B 5	D B 4	D B 3	D B 2	D B 1	D B 0	DESCRIPTION	EXECU. TIME (270KHz)
Clear Display	0	0	0	0	0	0	0	0	0	1	Clears entire display and returns the cursor to home position (address 0).	1.52ms
Return Home	0	0	0	0	0	0	0	0	1	x	Return the cursor to the home position. Also returns the display being shifted to the original position. DD RAM contents remain unchanged.	1.52ms
Entry mode set	0	0	0	0	0	0	0	1	I / D	S	Set cursor move direct and specifies display shift. These operations are performed during data rite/read. For normal operation, set S to zero. I/D=1: increment; 0: decrement; S=1: accompanies display shift when data is written, for normal operation, set to zero.	38 μs
Display ON/OFF control	0	0	0	0	0	0	1	D	C	B	Set ON/OFF all display (D), cursor ON/OFF(C), and blink of cursor position character(B). D=1: ON display; 0:OFF display. C=1: ON cursor;0: OFF cursor. B=1: ON blink cursor; 0: OFF blink cursor.	38 μs
Cursor or Display shift	0	0	0	0	0	1	S / C	R / L	x	x	Move the cursor and shift the display without changing DD RAM contents. S/C=1: Display shift; 0:Cursor move. R/L=1: shift to right; 0: shift to left.	38 μs
Function Set	0	0	0	0	1	D L	N	F	x	x	Set the interface data length (DL). Number of display lines (N) and character font (F). DL=1: 8 bits; 0:4 bits. N=1: 2 lines; 0: 1 lines. F=1: 5x10 dots; 0: 5x7 dots.	38 μs
Set CG RAM address	0	0	0	1	ACG					Set CG RAM address. CG RAM data is sent and received after this setting.	38 μs	
Set DD RAM address	0	0	1	ADD					Set DD RAM address. DD RAM data is sent and received after this setting	38 μs		
Read busy flag & address	0	1	B F	AC					Reads Busy Flag (BF) indicating internal operation is being performed and reads address counter contents. BF=1: internally operating. 0: can accept instruction	--		
Write Data to CG/DDRAM	1	0	WRITE DATA					Write data into DD RAM or CG RAM.			38 μs	
Read Data for CG/DDRAM	1	1	READ DATA					Read data from DD RAM or CG RAM			38 μs	

14. User Font Patterns (CG RAM Character)

Character Code (DD RAM data)			CG RAM Address		Character Pattern (CG RAM data)						
Hi	7 6 5 4 3 2 1 0	Lo	5 4 3	2 1 0	Hi	7 6 5	4 3 2 1 0	Lo			
0000x000			000	000	xxx	1 1 1 1 0					
			001	001	xxx	1 0 0 0 1					
			010	010	xxx	1 0 0 0 1					
			011	011	xxx	1 1 1 1 0					
			100	100	xxx	1 0 1 0 0					
			101	101	xxx	1 0 0 1 0					
			110	110	xxx	1 0 0 0 1					
			111	111	xxx	0 0 0 0 0					
0000x001			000	000	xxx	1 0 0 0 1					
			001	001	xxx	0 1 0 1 0					
			010	010	xxx	1 1 1 1 1					
			011	011	xxx	0 0 1 0 0					
			100	100	xxx	1 1 1 1 1					
			101	101	xxx	0 0 1 1 0					
			110	110	xxx	0 0 1 0 0					
			111	111	xxx	0 0 0 0 0					
0000x111			000	000							
			001	001							
			010	010							
			011	011							
			100	100							
			101	101							
			110	110							
			111	111							

15. Software Example

15.1 8-bit operation (8 bits 2 lines)

Function	R S	R w	D 7	D 6	D 5	D 4	D 3	D 2	D 1	D 0	Display	Description
Power on delay												Initialization. No display appears.
Function set	0	0	0	0	1	1	1	0	x	x		Sets to 8-bit operation and selects 2-line display and 5x7 dots character font. (Note: number of display lines and character fonts cannot be changed after this.)
Display OFF	0	0	0	0	0	0	1	0	0	0		Turn off display.
Display ON	0	0	0	0	0	0	1	1	1	0	_	Turn on display and cursor
Entry Mode Set	0	0	0	0	0	0	0	1	1	0	-	Set mode to increment the address by one and to shift the cursor to the right, at the time of write, to the DD/CG RAM Display is not shifted.
Write data to CG/DD RAM	1	0	0	1	0	1	0	0	1	1	S_	Write "S". Cursor incremented by one and shift to right.
Write data to CG/DD RAM	1	0	0	1	0	0	0	1	0	0	SDEC_	Write "D", "E", and "C".
Write data to CG/DD RAM	1	0	0	1	0	0	0	1	0	1		
Set DD RAM	0	0	1	1	0	0	0	0	0	0	SDEC	Set RAM address so that the cursor is propositioned at the head of the second line.
Write data to CG/DD RAM				*	*						SDEC CR_	Write "C" and "R".
Cursor or display shift	0	0	0	0	0	1	0	0	x	x	SDEC CR	Shift only the cursor position to the left.
Write data to CG/DD RAM				*	*						SDEC CO., LTD._	Write "O., LTD.".
Entry Mode Set	0	0	0	0	0	0	0	1	1	1	SDEC CO., LTD._	Set display mode shift at the time during writing operation.
Write data to CG/DD RAM	1	0	0	1	1	1	1	0	0	0	DEC O., LTD. x	Write "x". Cursor incremented by one and shift to right. (The display move to left.)
Write data to CG/DD RAM				*	*							Write other characters.
Return Home	0	0	0	0	0	0	0	0	1	0	SDEC CO., LTD.	Return both display and cursor to the original position (Set address to zero).

15.2 4-bit operation (4-bit, 1 line)

Function	RS	R/ W	D7	D6	D5	D4	Display	Description
Power on delay								Initialization. No display appears.
Function set	0	0	0	0	1	0		Sets to 4-bit operation. In this case, operation is handled as 8-bits by initialization, and only this instruction completes with one write.
Function set	0	0	0	0	1	0		Sets 4-bit operation and selects 1-line display and 5x7 dot character font on and resetting is needed. (Number of display lines and character fonts cannot be changed hence after).
Function set	0	0	0	0	x	x		(Number of display lines and character fonts cannot be changed hence after).
Display ON/OFF Control	0	0	0	0	0	0	-	Turn on display and cursor.
Display ON/OFF Control	0	0	1	1	1	0		
Entry Mode Set	0	0	0	0	0	0	-	Set mode to incremented the address by one and to shift the cursor to the right, at the time of write. To the DD/CG RAM display is not shifted.
Entry Mode Set	0	0	0	1	1	0		
Write data to CG/DD RAM	1	0	0	1	0	1	S_	Write "S". Cursor incremented by one and shift to right.
Write data to CG/DD RAM	1	0	0	0	1	1		

same as 8-bit operation

16. Character Generator ROM Map

Higher 4 bit Lower 4 bit		CHARACTER PATTERN CHART (5x7DOTS+CURSOR)															
		0000	0010	0011	0100	0101	0110	0111	1010	1011	1100	1101	1110	1111			
Lower 4-bit (D0-D3) of Character Code (Hexadecimal)	xxxx0000	CG RAM (1)		0	1	2	3	4	5	6	7	8	9	A	B	C	D
	xxxx0001	(2)	!	1	A	Q	a	q	0	7	+	4	ä	g			
	xxxx0010	(3)	"	2	B	R	b	r	1	8	u	x	pe	e			
	xxxx0011	(4)	#	3	C	S	c	s	2	9	t	e	e	e	o		
	xxxx0100	(5)	\$	4	D	T	d	t	3	0	h	h	h	h	o		
	xxxx0101	(6)	%	5	E	U	e	u	4	1	l	l	l	l	o		
	xxxx0110	(7)	&	6	F	V	f	v	5	2	m	m	m	m	o		
	xxxx0111	(8)	'	7	G	W	g	w	6	3	n	n	n	n	o		
	xxxx1000	(1)	(8	H	X	h	x	7	4	o	o	o	o	o		
	xxxx1001	(2))	9	I	Y	i	y	8	5	p	p	p	p	o		
	xxxx1010	(3)	*	0	J	Z	j	z	9	6	q	q	q	q	o		
	xxxx1011	(4)	+	1	K	[k	[0	7	r	r	r	r	o		
	xxxx1100	(5)	,	<	L]	l]	1	8	s	s	s	s	o		
	xxxx1101	(6)	-	=	M	^	m	^	2	9	t	t	t	t	o		
	xxxx1110	(7)	.	>	N	_	n	_	3	0	u	u	u	u	o		
	xxxx1111	(8)	/	?	O	~	o	~	4	1	v	v	v	v	o		

17. Functional Test & Inspection Criteria

17.1 Sample plan

Sample plan according to MIL-STD-105D level 2, and acceptance/rejection criteria is.

Base on: Major defect: AQL 0.65 Minor defect: AQL 2.5

17.2 Inspection condition

Viewing distance for cosmetic inspection is 30cm with bare eyes, and under an environment of 800 lus (20W) light intensity. All direction for inspecting the sample should be within 45° against perpendicular line.

17.3 Definition of Inspection Zone in LCD

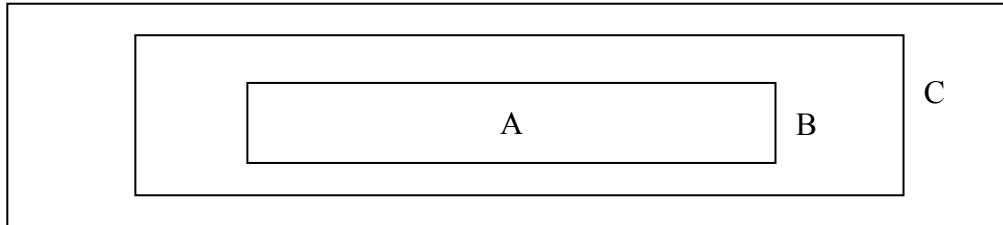

Zone A: Character / Digit area

Zone B: Viewing area except Zone A (Zone A + Zone B = minimum Viewing area)

Zone C: Outside viewing area (invisible area after assembly in customer's product)

Note: As a general rule, visual defects in Zone C are permissible, when it is no trouble for quality and assembly of customer's product.

17.4 Major Defect

All functional defects such as open (or missing segment), short, contrast differential, excess power consumption, smearing, leakage, etc. and overall outline dimension beyond the drawing. Are classified as major defects.

17.5 Inspection Parameters And Glass Pixel

No	Polarizer)	Criteria				
		Zone	Acceptable number			
1	Black or White spots and Piercing	Dimension (mm)	A	B	C	
		$D \leq 0.15$	*	*	*	
		$0.15 < D \leq 0.2$	4	6	*	
		$0.2 < D \leq 0.3$	2	2	*	
		$0.3 < D$	0	0	*	
		D=(Length+Width/2 * : Disregard				
2	Scratch	Zone X(mm)	Zone Y(mm)	Acceptable number		
		*	$0.04 \geq W$	A	B	C
		$3.0 \geq L$	$0.06 \geq W$	4	4	*
		$2.0 \geq L$	$0.08 \geq W$	2	2	*
		--	$0.10 \geq W$	0	0	*
		X : Length Y : Width * : Disregard				
3	Air Bubbles (between glass & polarizer)	Zone	Acceptable number			
		Dimension (mm)	A	B	C	
		$D \leq 0.20$	*	*	*	
		$0.20 < D \leq 0.50$	2	2	*	
		$0.50 < D$	0	0	*	
		* : Disregard				

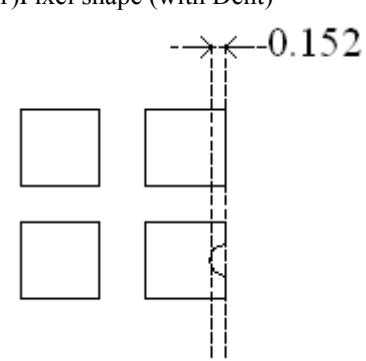
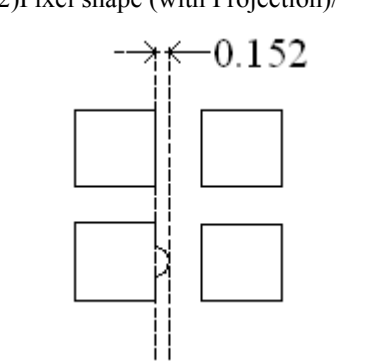
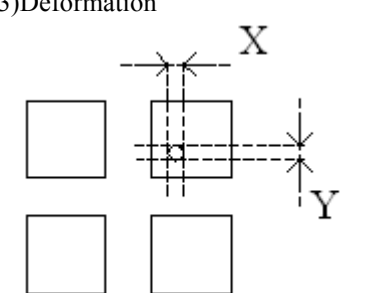
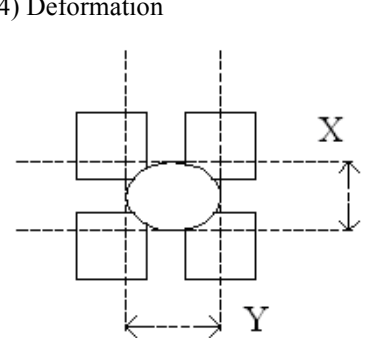
4	Glass of Pixel	<p>(1) Pixel shape (with Dent)</p>  <ul style="list-style-type: none"> • Less than 0.152 mm is no counted (0.152mm) <p>(2) Pixel shape (with Projection)/</p>  <p>Should not be connected next pixel</p> <p>(3) Deformation</p>  <p>$(X + Y) / 2 \leq 0.15\text{mm}$</p> <ul style="list-style-type: none"> • Less than 0.1 mm is no counted (0.15mm) <p>(4) Deformation</p>  <p>$(X + Y) / 2 \leq 0.3\text{mm}$</p> <ul style="list-style-type: none"> • Less than 0.3 mm is no counted (0.3mm)
---	----------------	---

18. Reliability Test – Normal Temperature

No change no display and in operation under the following text condition.

Conditions : Unless otherwise specified, test will be conducted under the following condition.

Temperature : $20 \pm 5^\circ\text{C}$

Humidity : $40 \pm 5\%RH$

Tests will be not conducted under functioning state.

$20 \pm 5^\circ\text{C}$: $40 \pm 5\%RH$

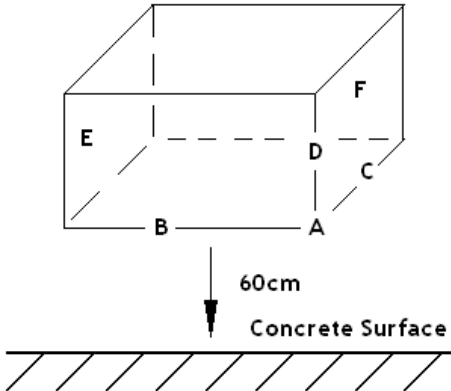
NO	Parameter	Conditions	Notes
1	High Temperature Operating	$50^\circ\text{C} \pm 2^\circ\text{C}$, 96 hrs (operation state)	
2	Low Temperature Operating	$0^\circ\text{C} \pm 2^\circ\text{C}$, 96 hrs (operation state)	1
3	High Temperature Storage	$60^\circ\text{C} \pm 2^\circ\text{C}$, 96 hrs	2
4	Low Temperature Storage	$-10^\circ\text{C} \pm 2^\circ\text{C}$, 96 hrs	1, 2
5	Damp Proof Test	$40^\circ\text{C} \pm 2^\circ\text{C}$, 85 ~ 90%RH, 96hr	1, 2
6	Vibration Test	Total fixed amplitude: 1.5 mm Vibration Frequency : 10 ~ 55 Hz One cycle 60 seconds to 3 directions of X, Y, Z for each 15 minutes	3
7	Shock Test	To be measured after dropping from 60cm high on the concrete surface in packing state.  <p style="margin-left: 200px;">Dropping method comer dropping A comer : once Edge dropping B, C, D edge : once Face dropping E, F, G face : once</p>	

Note 1 : No dew condensation to be observed. Note 2 : The function test shall be conducted after 4 hours storage at the normal

Temperature and humidity after removed from the test chamber
 (Temp : 25°C , Humidity : 45%RH)

Note 3 : Vibration test will be conducted to the product itself without putting it in a container.

19. Reliability Test – Wide Temperature

No change no display and in operation under the following text condition.

Conditions : Unless otherwise specified, test will be conducted under the following condition.

Temperature : $20 \pm 5^\circ\text{C}$

Humidity : $40 \pm 5\%RH$

Tests will be not conducted under functioning state.

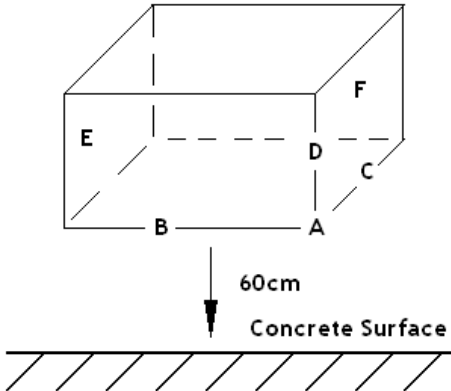
NO	Parameter	Conditions	Notes
1	High Temperature Operating	$70^\circ\text{C} \pm 2^\circ\text{C}$, 96 hrs (operation state)	
2	Low Temperature Operating	$-20^\circ\text{C} \pm 2^\circ\text{C}$, 96 hrs (operation state)	1
3	High Temperature Storage	$80^\circ\text{C} \pm 2^\circ\text{C}$, 96 hrs	2
4	Low Temperature Storage	$-30^\circ\text{C} \pm 2^\circ\text{C}$, 96 hrs	1 , 2
5	Damp Proof Test	$40^\circ\text{C} \pm 2^\circ\text{C}$, 85 ~ 90%RH , 96hr	1 , 2
6	Vibration Test	Total fixed amplitude : 1.5 mm Vibration Frequency : 10 ~ 55 Hz One cycle 60 seconds to 3 directions of X , Y , Z for each 15 minutes	3
7	Shock Test	To be measured after dropping from 60cm high on the concrete surface in packing state.  Dropping method comer dropping A comer : once Edge dropping B , C , D edge : once Face dropping E , F , G face : once	

Note 1 : No dew condensation to be observed.

Note 2 : The function test shall be conducted after 4 hours storage at the normal

Temperature and humidity after removed from the test chamber
(25°C : 45%RH) ,

Note 3 : Vibration test will be conducted to the product itself without putting it in a container.