



FocusLCDs.com
LCDs MADE SIMPLE®

Ph. 480-503-4295 | LCD@FocusLCD.com

TFT | CHARACTER | UWVD | FSC | SEGMENT | CUSTOM | REPLACEMENT

Graphic Display Module

Part Number

G12864C-YTY-LW653

Overview:

- 128x64 dots
- Area: 89.7x49.8mm
- Viewing Area: 68.0x 35.5mm
- STN Yellow Positive
- 8-bit Parallel Interfaces
- Wide Temp
(-20° - 70°C operating / -30° - 80°C storage)
- Bottom View
- Transmissive
- 3V LCD
- 5V LED backlight
- Controller: ST7565P
- RoHS Compliant

Graphic LCD Features

Resolution: 128x64 dots

Interfaces: 8-bit parallel, 8080 and 6800

Built in IC Controller: ST7565P

Built in DC to DC Circuits

RoHS Compliant

General Information Items	Specification	Unit	Note
	Main Panel		
Viewing Area	68.0(L) x 35.5(W)	mm	-
LCD Type	STN Yellow Positive	-	-
Viewing Direction	6:00	o'clock	-
Rear Polarizer	Transflective	-	-
Number of Pixels	128x64	dots	-
Backlight Type	LED	-	5V
Backlight Color	Yellow	-	-
Controller IC	ST7565P	-	-
Interfaces	8-bit parallel MCU	-	8080 & 6800
DC to DC Circuit	Built In	-	-
Operating temperature	-20~+70	°C	-
Storage temperature	-30~+80	°C	-

Mechanical Information

Item		Min	Typ.	Max	Unit	Note
Module size	Length (L)		89.7		mm	-
	Width (W)		49.8		mm	-
	Height (H)		6.0		mm	-

1. Outline Dimensions

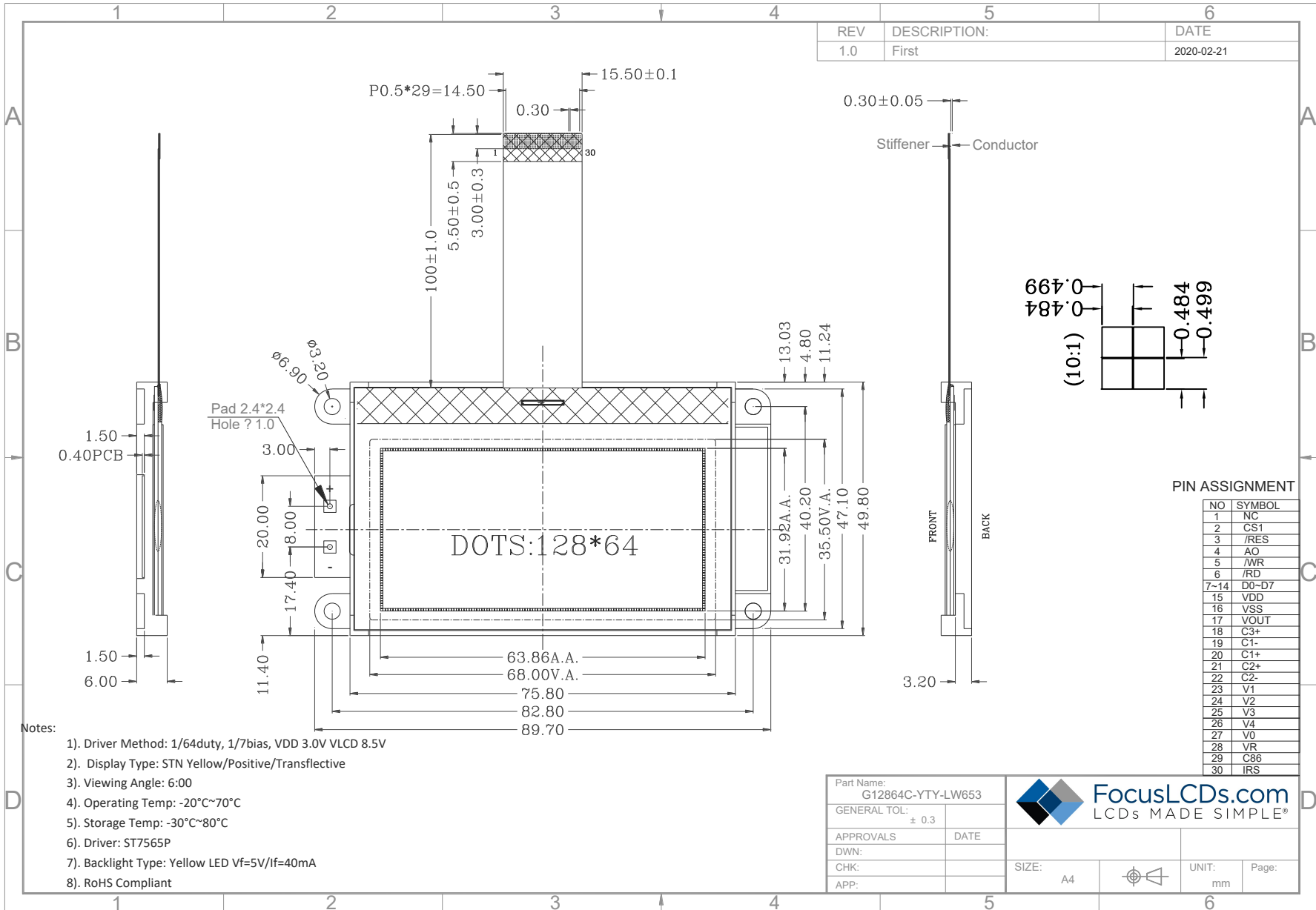

2. Block Diagrams

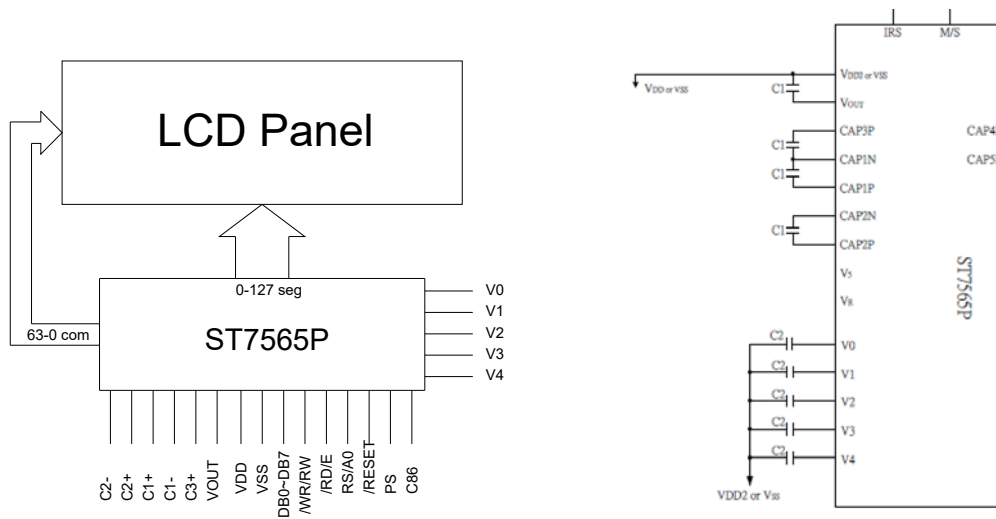

C1 1uF~4.7uF
C2 0.1uF~4.7uF

NOTE: See IC controller spec ST7565P for more information on internal voltage regulating circuits. Additional information on DC-DC voltage regulating circuits for graphic LCD's is available on our website at www.FocusLCDs.com.

3. Input Terminal Pin Assignment

Recommended Connector: FH19C-30S-0.5SH(99)

NO.	Symbol	Description	I/O
1	NC	Not connected	
2	/CS1	Chip select in serial interface. Low active.	P
3	/RES	External reset pin of the device. Must be fixed to VDD. Low active.	MPU
4	A0/RS	Select registers. 0: Instruction, 1: Data register.	MPU
5	/WR/RW	Read/write select signal	MPU
6	RD/E	Operation data read/data write enable signal	MPU
7-14	DB0-DB7	8-bit directional data bus. In serial interface D6=SCL and D7=SI.	MPU
15	VDD	Power supply for logic for the LCM	P
16	VSS	Signal ground for the LCM	P
17	VOUT	DC/DC voltage converter	P
18	C3+	Voltage boosting circuit.	P
19	C1-		P
20	C1+		P
21	C2+		P
22	C2-		P
23	V1	Power supply for the LCD.	P
24	V2		P
25	V3		P
26	V4		P
27	V0		P
28	VR	Voltage adjustment pad. Applies voltage between V0 and VSS using a variable resistance voltage divider.	P
29	C86	MPU interface switch terminal	MPU
30	IRS	Resistor selection terminal for the V0 voltage level adjustment.	MPU

4. LCD Optical Characteristics

4.1 Optical Specifications

STN Type Display Module

(Ta=25°C, VDD=3.0V)

Item	Symbol	Condition	Min	Typ.	Max	Unit	Note	
Contrast Ratio	CR	Ta=25°C	3	5	--	--		
Response Time	Rising		TR	--	150	250	ms	
	Falling		TF	--	200	300		
Viewing Angle	Left-Right		θ	--	60	--	degree	
	Top-Bottom		θ	--	70	--		

5. Electrical Characteristics

5.1 Absolute Maximum Rating (Ta=25 °C, VSS=0V)

Characteristics	Symbol	Min	Max	Unit
Power Voltage Logic	VDD-VSS	0.3	3.6	V
Input Voltage	VIN	-0.3	VDD+0.3	V
Power Supply Voltage for LCD	V0-VSS	-0.3	13.5	V
Operating Temperature	TOP	-20	+70	°C
Storage Temperature	TST	-30	+80	°C

NOTE: If the absolute maximum rating of the above parameters is exceeded, even momentarily, the quality of the product may be degraded. Absolute maximum ratings specify the values which the product may be physically damaged if exceeded. Be sure to use the product within the range of the absolute maximum ratings.

5.2 DC Electrical Characteristics

Characteristics	Symbol	Conditions	Min	Typ.	Max	Unit
Supply Voltage for LCD	V0-VSS	Ta=25°C	8.3	8.5	8.7	V
Supply Voltage for Logic	VDD		2.85	3.0	3.15	V
Supply Current	IDD	Ta=25°C, VDD=3.0V	--	0.5	--	mA
Backlight Supply Voltage	VF		4.8	5.0	5.2	V
Backlight Supply Current	ILED	VF=5.0V	20	40	60	mA

6. Signal Timing Characteristics

6.1 8-bit Parallel Timing Characteristics (8080-series)

Parameter	Signal	Symbol	Min	Max	Unit	Note
Address hold time	A0	t _{AH8}	0	--	ns	
Address setup time		t _{AW8}	0	--	ns	
Address cycle time		t _{CYC8}	240	--	ns	
Enable L pulse width (write)	WR	t _{CCLW}	80	--	ns	
Enable H pulse width (write)		t _{CCHW}	80	--	ns	
Enable L pulse width (read)	RD	t _{CCLR}	140	--	ns	
Enable H pulse width (read)		t _{CCHR}	80	--	ns	
Write data setup time	DB0-DB7	t _{DS8}	40	--	ns	
Write address hold time		t _{DH8}	0	--	ns	
Read access time		t _{ACC8}	--	70	ns	CL=100pF
Read output disable time		t _{OH8}	5	50	ns	CL=100pF

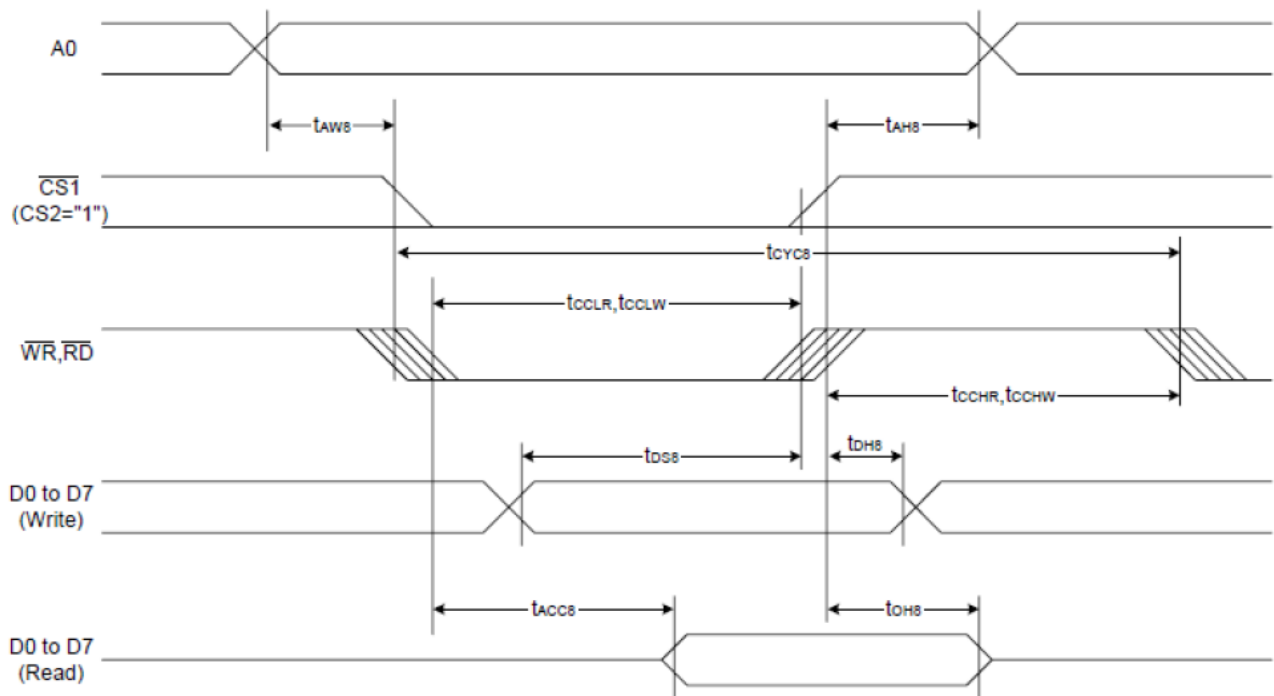

6.2 8-bit Parallel Timing Characteristics (6800-series)

Parameter	Signal	Symbol	Min	Max	Unit	Note
Address hold time	A0	t_{AH6}	0	--	ns	
Address setup time		t_{AW6}	0	--	ns	
Address cycle time		t_{CYC6}	240	--	ns	
Enable L pulse width (write)	WR	t_{CCLW}	80	--	ns	
Enable H pulse width (write)		t_{CCHW}	80	--	ns	
Enable L pulse width (read)	RD	t_{CCLR}	80	--	ns	
Enable H pulse width (read)		t_{CCHR}	140	--	ns	
Write data setup time	DB0-DB7	t_{DS6}	40	--	ns	
Write address hold time		t_{DH6}	0	--	ns	
Read access time		t_{ACC6}	--	70	ns	CL=100pF
Read output disable time		t_{OH6}	5	50	ns	CL=100pF

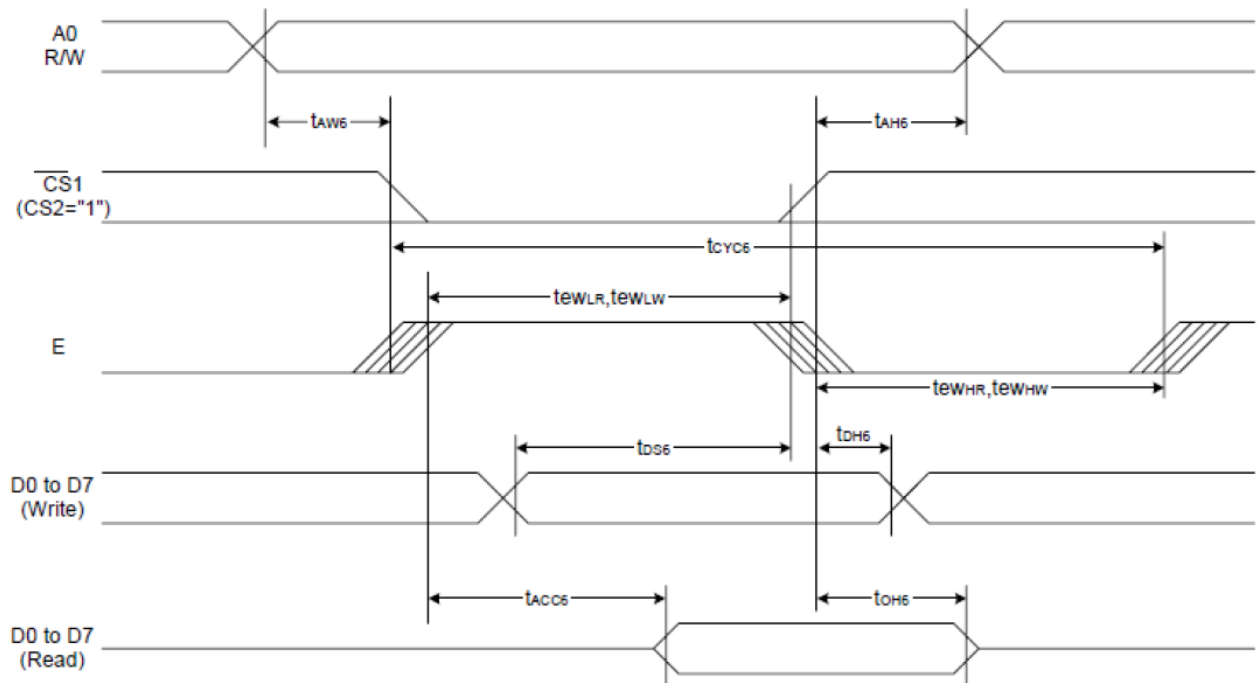

6.3 Serial Interface

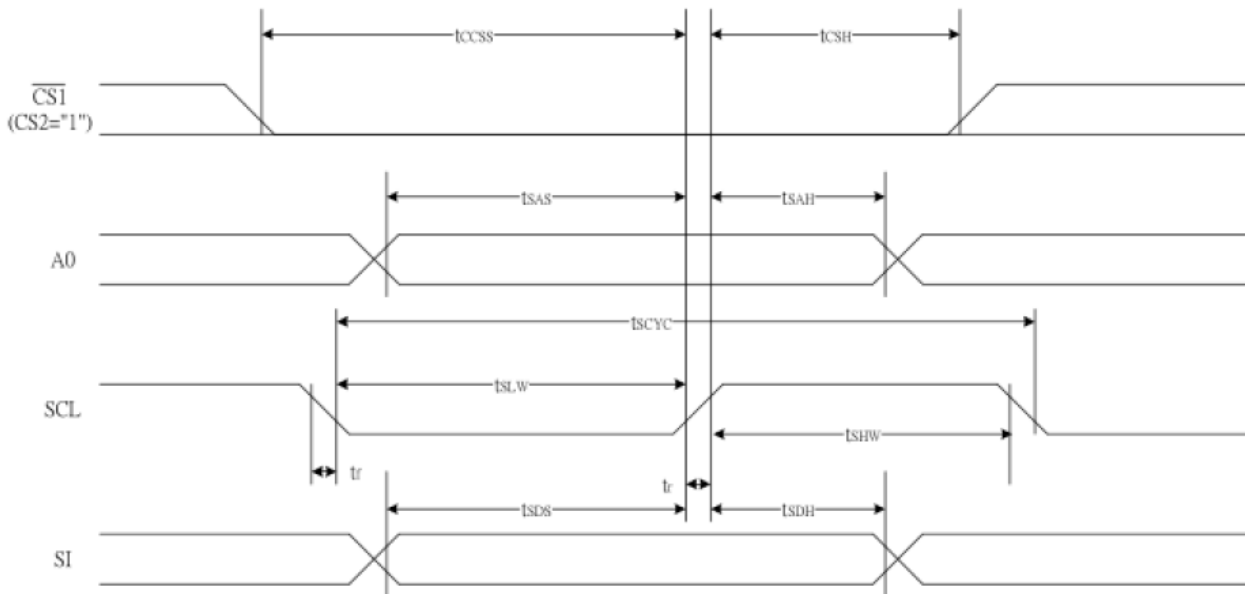

(VDD=3.3V, Ta=-30 to 85°C)

Parameter	Signal	Symbol	Min	Max	Unit	Note
Serial Clock Period	SCL	T _{scyc}	50	--	ns	
SCL "H" pulse width		T _{shw}	25	--	ns	
SCL "L" pulse width		T _{slw}	25	--	ns	
Address setup time	A0	T _{sas}	20	--	ns	
Address hold time		T _{sah}	10	--	ns	
Data setup time	SI	T _{sds}	20	--	ns	
Data hold time		T _{sdh}	10	--	ns	
CS-SCL time	CS	T _{css}	20	--	ns	
CS-SCL time		T _{csh}	40	--	ns	

(VDD=2.7V, Ta=-30 to 85°C)

Parameter	Signal	Symbol	Min	Max	Unit	Note
Serial Clock Period	SCL	T _{scyc}	100	--	ns	
SCL "H" pulse width		T _{shw}	50	--	ns	
SCL "L" pulse width		T _{slw}	50	--	ns	
Address setup time	A0	T _{sas}	30	--	ns	
Address hold time		T _{sah}	20	--	ns	
Data setup time	SI	T _{sds}	30	--	ns	
Data hold time		T _{sdh}	20	--	ns	
CS-SCL time	CS	T _{css}	30	--	ns	
CS-SCL time		T _{csh}	60	--	ns	

6.4 Reset Timing

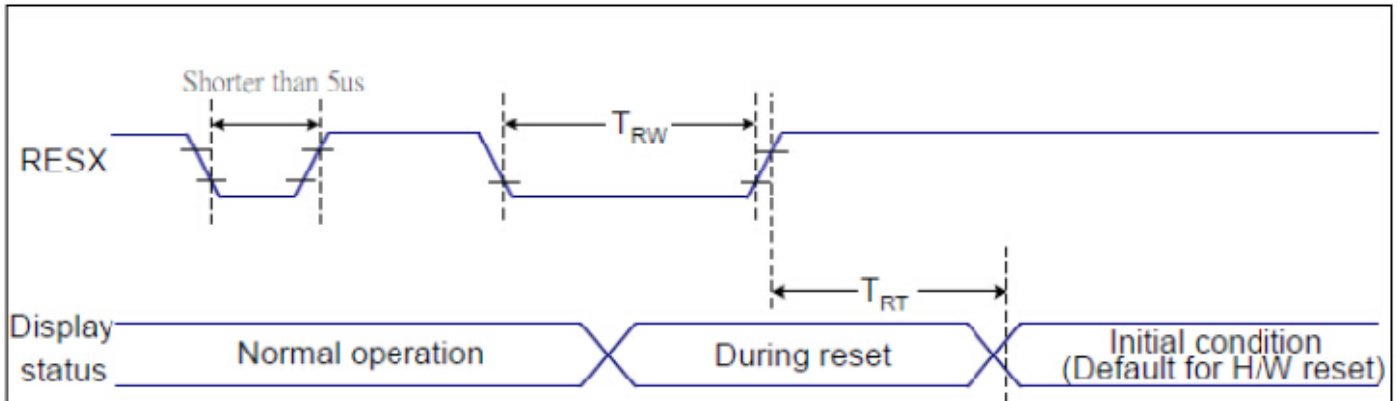

Related Pins	Symbol	Parameter	Min	Max	Unit
RESX	TRW	Reset pulse duration	10	-	us
	TRT	Reset cancel	-	5 (Note 1,5)	ms
				120 (Note 1, 6, 7)	ms

Notes:

- The reset cancel includes also required time for loading ID bytes, VCOM setting and other settings from NVM (or similar device) to registers. This loading is done every time when there is HW reset cancel time (tRT) within 5ms after a rising edge of RESX.
- Spike due to an electrostatic discharge on RESX line does not because irregular system reset according to the table below:

RESX Pulse	Action
Shorter than 5us	Reset Rejected
Longer than 9us	Reset
Between 5us and 9 us	Reset starts

- During the resetting period, the display will be blanked (the display is entering blanking sequence, which maximum time is 120ms, when reset starts in Sleep Out mode. The display remains the blank state in Sleep in mode) and then return to Default condition for Hardware Reset.
- Spike Rejection also applies during a valid reset pulse as shown below:

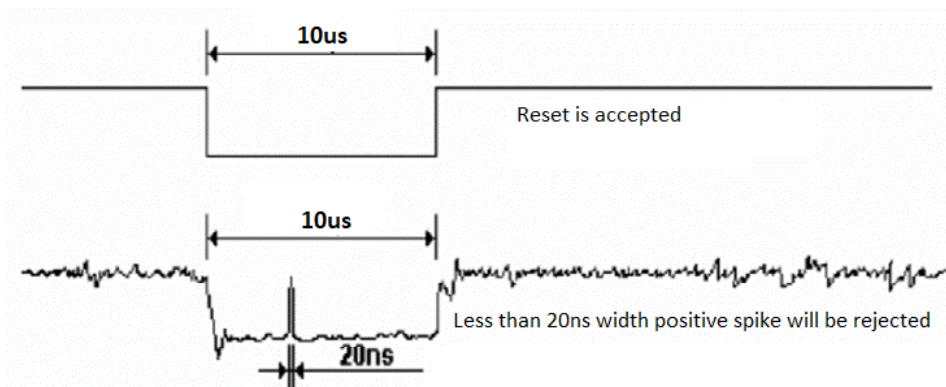

- When Reset applied during Sleep In Mode.
- When Reset applied during Sleep Out Mode.
- It is necessary to wait 5ms after releasing RESX before sending commands. Also Sleep Out command cannot be sent for 120ms.

7. Commands for Initialization of the Display

Command	A0 RD WR	D7 D6 D5 D4 D3 D2 D1 D0	Description
Display On/Off	0 1 0	1 0 1 0 1 1 1 0/1	Display on/off, 0: OFF, 1:ON
Display start line set	0 1 0	0 1 Display start address	Sets RAM start address
Page address set	0 1 0	1 0 1 1 Page address	Sets RAM page address
Column address set	0 1 0	0 0 0 1 MS col address	Sets most MSB of RAM column address
Status read	0 0 1	Status 0 0 0 0	Reads status of data
Display data write	1 1 0	Write data (D3-D1)	Writes data to RAM
Display data read	1 0 1	Read data (D3-D1)	Reads data from RAM
Display normal/reverse	0 1 0	1 0 1 0 0 0 0 0	Sets display in normal or reverse mode. 0:normal, 1:reverse
Display all points On/Off	0 1 0	1 0 1 0 0 1 0 0	Display all points. 0: normal, 1: all points on
LCD bias set	0 1 0	1 0 1 0 0 0 0 0/1	Set LCD voltage bias ratio. 0: 1/9 bias, 1: 1/7 bias
Read modify write	0 1 0	1 1 1 0 0 0 0 0	Column address increment
End	0 1 0	1 1 1 0 1 1 1 0	Clear read/modify/write
Reset	0 1 0	1 1 1 0 0 0 1 0	Internal reset
Power control set	0 1 0	0 0 1 0 1 Mode	Internal power supply operating mode
V0 voltage regulator, internal resistor ratio set	0 1 0	0 0 1 0 1 Res. ratio	Select internal resistor ratio (Rb/Ra) mode
Electronic volume mode set	0 1 0	1 0 0 0 0 0 0 1	Set V0 output voltage
Electronic volume register set	0 1 0	0 0 Electronic volume	Electronic volume value
Sleep mode set	0 1 0	1 0 1 0 1 1 0 0	0: Sleep mode, 1: Normal mode
Booster ratio set	0 1 0	1 1 1 1 1 0 0 0 0 0 0 0 0 0 step-up	Select booster ratio 00: 2x, 3x, 4x 01:5x, 11: 6x
NOP	0 1 0	1 1 1 0 0 0 1 1	Command for non-operation

For more information on commands and register instructions for your display, please visit FocusLCDs.com! Additional information can be found in the IC controller specification sheet ST7565P.

8. Cautions and Handling Precautions

8.1 Handling and Operating the Module

1. When the module is assembled, it should be attached to the system firmly. Do not warp or twist the module during assembly work.
2. Protect the module from physical shock or any force. In addition to damage, this may cause improper operation or damage to the module and back-light unit.
3. Note that polarizer is very fragile and could be easily damaged. Do not press or scratch the surface.
4. Do not allow drops of water or chemicals to remain on the display surface. If you have the droplets for a long time, staining and discoloration may occur.
5. If the surface of the polarizer is dirty, clean it using some absorbent cotton or soft cloth.
6. The desirable cleaners are water, IPA (Isopropyl Alcohol) or Hexane. Do not use ketene type materials (ex. Acetone), Ethyl alcohol, Toluene, Ethyl acid or Methyl chloride. It might permanent damage to the polarizer due to chemical reaction.
7. If the liquid crystal material leaks from the panel, it should be kept away from the eyes or mouth. In case of contact with hands, legs, or clothes, it must be washed away thoroughly with soap.
8. Protect the module from static, it may cause damage to the CMOS ICs.
9. Use fingerstalls with soft gloves in order to keep display clean during the incoming inspection and assembly process.
10. Do not disassemble the module.
11. Protection film for polarizer on the module shall be slowly peeled off just before use so that the electrostatic charge can be minimized.
12. Pins of I/F connector shall not be touched directly with bare hands.
13. Do not connect, disconnect the module in the "Power ON" condition.
14. Power supply should always be turned on/off by the item Power On Sequence & Power Off Sequence.

8.2 Storage and Transportation

1. Do not leave the panel in high temperature, and high humidity for a long time. It is highly recommended to store the module with temperature from 0 to 35 °C and relative humidity of less than 70%
2. Do not store the Graphic LCD module in direct sunlight.
3. The module shall be stored in a dark place. When storing the modules for a long time, be sure to adopt effective measures for protecting the modules from strong ultraviolet radiation, sunlight, or fluorescent light.
4. It is recommended that the modules should be stored under a condition where no condensation is allowed. Formation of dewdrops may cause an abnormal operation or a failure of the module. In particular, the greatest possible care should be taken to prevent any module from being operated where condensation has occurred inside.
5. This panel has its circuitry FPC on the bottom side and should be handled carefully in order not to be stressed.